

**MATERIALS & EQUIPMENT
FOR DIEMAKERS.**

**PACKAGING.
PERFORMANCE.
YOU.**

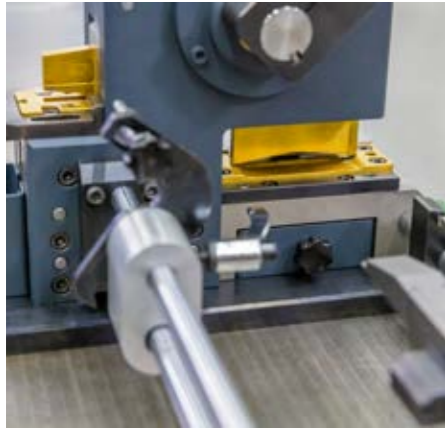

MATERIALS & EQUIPMENT. THE RIGHT ONE FOR EVERYONE.

Marbach Die Supplies provides the cutting die industry worldwide with materials and equipment for the production of cutting dies. The product portfolio of Marbach Die Supplies is extensive and very diverse. It offers the right solution for every requirement.

From A like aluhammer, over C like cutting rules and carrier plate materials, F like finishing tape to R like rubber material. We at Marbach have almost all materials in our product range that you need for the production of your cutting dies.

The special thing about our materials: They are characterized by their quality and are all specially designed for the use in the production of cutting dies. Our product range also includes numerous tools that make your day-to-day work easier: Nick setters, small tools, rule pullers, pliers and measuring devices. But we also offer in-house developments such as mpower cutting rules or marbastrip claws. And much more.

Use the materials and equipment from Marbach. Use the decades of experience of the world market leader. For best performance in your production.

All products from our catalog are available at Marbach Die Supplies: supplies@marbach.com.

Notes regarding this catalog:

Packaging units are subject to change | Marbach General Terms and Conditions apply (www.marbach.com/en/daten/general-terms-and-conditions) | Pictures without guarantee | Item properties may vary | Further items and designs on request.



Make-ready materials	6
Counter plates	8
rillma +	
Cutting plates	
Cutting chase cover plates	12
Nicks	14
Grinding discs	
Nick grinder	
marbanick 2+	
Nick-changing-system	
Handheld devices	16
mcut multi	
mbend	
mcut round	
mcut matrix	
mcut notch	
Workbenches, lamps & trimknife	18
Tools	20
Dieboard materials	22
Flat plywood	
Rotary half shell	
Knifing	24
Cutting rules	
Creasing rules	
Perforation rules. Combo perforation rules	
Tear perforation rules	
Special rules	
Punches	36
Safety cuts	37
Rubbering Paperboard	38
Rubbering corrugated	40
Flat cutting	
Rotary cutting	
Rubber plates	44
Corrugated and Paperboard	
Accessories	
Small components	46
Braille	48
Steel and wooden bar	49
Stripping	50
Blanking	54



MAKE-READY MATERIALS. SELF-ADHESIVE TAPES.

Make-ready tape, paper

Name	Item no.	Version	PU
blue	03030	30µm, 3 mm width	40 pcs.
blue	05830	30µm, 6 mm width	25 pcs.
blue	12030	30µm, 12 mm width	12 pcs.
red	03050	50µm, 3 mm width	40 pcs.
red	05850	50µm, 6 mm width	25 pcs.
red	12050	50µm, 12 mm width	12 pcs.
yellow	03080	80µm, 3 mm width	40 pcs.
yellow	05880	80µm, 6 mm width	25 pcs.
yellow	12080	80µm, 12 mm width	12 pcs.

Make-ready tape, stainless steel

Name	Item no.	Version	PU
stainless steel	07399	30µm, 6.5 mm width	10 m/roll
stainless steel	07401	50µm, 6.5 mm width	10 m/roll
stainless steel	07402	100µm, 6.5 mm width	10 m/roll



MAKE-READY MATERIALS. TECHNICAL PAPERS.

Make-ready paper

Item	Item no.	Type	Version	PU
silk paper, white	09735	sheets	30µm, 100 cmx75 cm	1,000 pcs.

Make-ready sheets, plotter foil and carbon paper

Item	Item no.	Type	Version	PU
make-ready sheet, 3-layers	14412	50 m roll	100µm, 122 cm width	1 pc.
make-ready sheet, 2-layers	14432	30 m roll	145µm, 152.4 cm width	1 pc.
plotter foil, one side matt	00591	30 m roll	90µm, 122 cm width	1 pc.
one-time carbon paper	07060	950 m roll	74.5 cm width	1 pc.
one-time carbon paper	17050	sheets	430x610 mm	1,000 pcs.

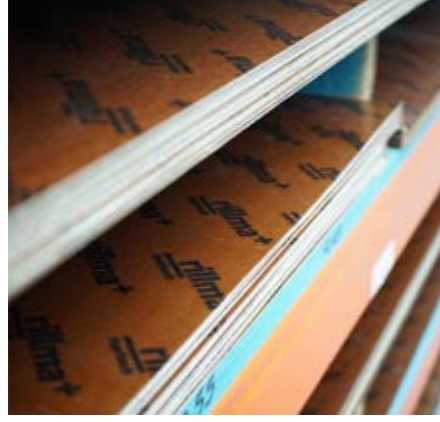

COUNTER PLATES.

rillma|+.

rillma + *	Full format (1,070 mm x 1,070 mm)	
Thickness	Item no.	PU
0.30 mm	09645	1 plate
0.40 mm	09646	1 plate
0.45 mm	09643	1 plate
0.50 mm	09647	1 plate
0.55 mm	09681	1 plate
0.60 mm	09650	1 plate
0.65 mm	09602	1 plate
0.70 mm	09651	1 plate
0.75 mm	09644	1 plate
0.80 mm	09652	1 plate

rillma + *	Half format (1,070 mm x 535 mm)	
Thickness	Item no.	PU
0.30 mm	09653	1 plate
0.40 mm	09654	1 plate
0.45 mm	09683	1 plate
0.50 mm	09655	1 plate
0.55 mm	09810	1 plate
0.60 mm	09656	1 plate
0.65 mm	09611	1 plate
0.70 mm	09657	1 plate
0.75 mm	09615	1 plate
0.80 mm	09658	1 plate

*without adhesive film; item available with adhesive film

Accessories for rillma and steel counter plates

Item	Item no.	Version	PU
rillma pin standard	07094	5x18 mm; bevel max. 0.5 mm double-sided	1,000 pcs.
rillma pin plastic	08919	head Ø5.5 mm; base Ø8 mm; 21 mm long	100 pcs.
mecosol glue spray universal	07093	500 ml bottle	1 pc.
puller	07067	200 mm, grinded	1 pc.
puller	07156	200 mm, standard	1 pc.
steel counter plate socket	15013	for multiplex dies	100 pcs.
steel counter plate socket	14312	for duramar dies	100 pcs.
spring pins	07085	Ø6 mm x 20 mm, lightweight	500 pcs.
moose rubber rings**	07088	light grey, extra strong, Ø16 mm x 5 mm	1,190 pcs.
laminating film rillma	43027	roll 50 m x 1,050 mm x 40 µm	1 pc.

**further rubber rings on request

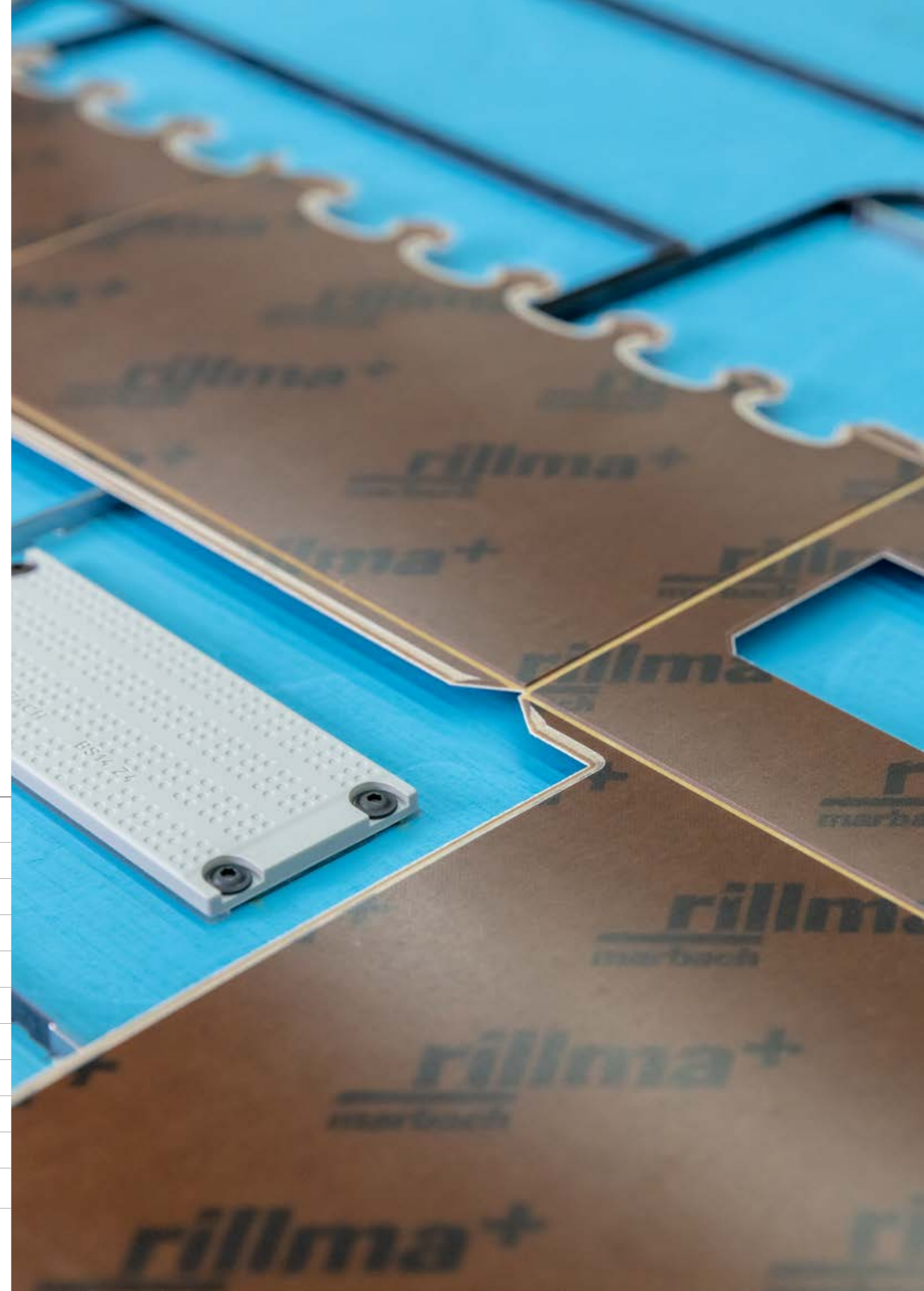



COUNTER PLATES. CUTTING PLATES.

We cut cutting plates to the contour required by your customers. Suitable for one or more machines, Marbach cutting plates are available in different versions and hardnesses. Medium hard (35 HRC) and hard (48 HRC), in different thicknesses. For every requirement.

Packaging unit medium hard plates: 10 pcs. | Packaging unit hard plates: 5 pcs.
Further versions as well as milled steel counter plates on request.

Paperboard processing machines

	Item no.
76	M-4900
102	M-4900
104	M-4900
106	M-4900
130	M-4900
142	M-4900
145	M-4900
162	M-4900

Corrugated board processing machines

	Item no.
1600	M-4900
1700	M-4900
2000	M-4900
2100	M-4900

Further sizes on request at supplies@marbach.com.



CUTTING CHASE. COVER PLATES.

With the cutting chase cover plate, you protect your make-ready sheet. And ensure optimum conditions in your platen area. For minimum make-ready times and maximum productivity.

Machine	Item no.	Thickness
102	M-0750	1mm
104	M-0750	1mm
106	M-0750	1mm
130	M-0750	1mm
142	M-0750	1mm
145	M-0750	1mm
162	M-0750	1mm
1600	M-0750	6 mm
1700	M-0750	6 mm
2000	M-0750	6 mm
2100	M-0750	6 mm

Accessories

Item	Item no.
Special bio cleaner (600 ml) for protection plate "digital zone levelling"	07193

Other sizes on request at supplies@marbach.com





NICK GRINDING. GRINDING DISCS.

For the use of a nick grinder you need the appropriate grinding discs. Diamond for a long lifetime. Or the cheaper version mafix, for variety in all sizes. Our grinding discs are available with a hole diameter of 6 or 8 mm.

Grinding discs	mafix (50 mm/6 mm hole diameter)	Diamond (50 mm/6 mm hole diameter)
Thickness	Item no.	Item no.
0.2mm	07002	912242
0.3mm	07003	912243
0.4mm	07004	912244
0.5mm	07005	912245
0.6mm	07006	912246
0.7mm	07007	912247
0.8mm	07008	912248
0.9mm	07009	912249
1.0mm	07010	912250
1.1mm	07011	912251
1.2mm	07012	912252
1.3mm	07013	912253
1.4mm	07014	912254
1.5mm	07015	912255
1.6mm	07016	912256
1.7mm	07017	912257
1.8mm	07018	912258
1.9mm	07019	912259
2.0mm	07020	912260
2.5mm	07025	912261
3.0mm	07000	912262

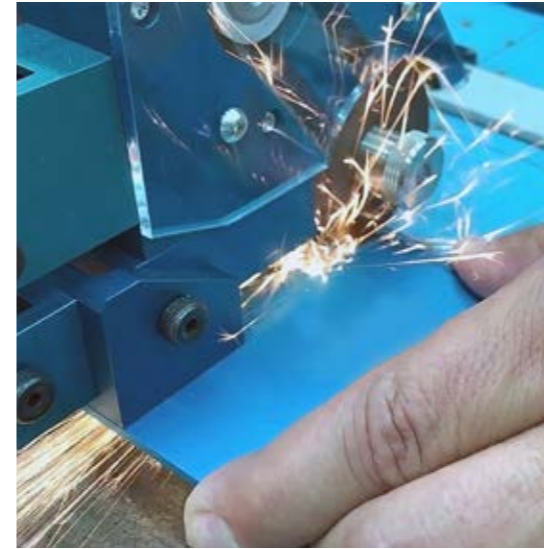

Nick grinder.

THE EFFECTIVE ONE.

Transport nicks should be ground in. For maximum strength. Best done by the diemaker with a CNC nick grinder. We have the right solution for every requirement.

Item no.	Name
G-2135	nick grinder battery
G-2143	nick grinder electric
G-2136	spare battery for G-2135

further nick grinders available on request



marbanick|2+.

THE FAST ONE.

For the subsequent optimization of waste nicks, the marbanick|2+ is the optimal solution. With its different impact levels, it combines the functionality of 3 devices in one. The marbanick|2+ impresses with its integrated quick-change function. And four different wedge sizes (0.3, 0.4, 0.5 and 0.6 mm). These features make the marbanick|2+ extremely flexible and cost-efficient.

Item no.	Name
34162	marbanick 2+



Nick changing system.

THE FLEXIBLE ONE.

Flexibility is important when it comes to nicks. That's what the nick changing system for corrugated applications is for. With it, a cutting die can be perfectly set-up for different material characteristics in the least possible time. Or how else would you remove an existing nick from a die?

Note: Special preparation of the cutting die is necessary.

Item no.	Name
04900	nick changing system case with accessories for flat corrugated
04900	nick changing system case with accessories for rotary corrugated

mcut|multi. THE ALLROUNDER.



An indispensable handheld device. 3 devices in one. Multi-functional and with digital gauge. The mcut|multi can not only cut rules, but also lips. And it can also notch. For rule materials from 2 pt to 3 pt. It cuts steel quickly and without deformation. And it does so with a very small footprint.

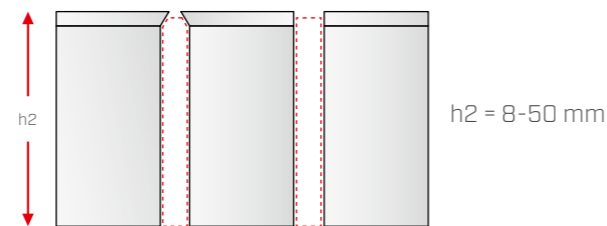
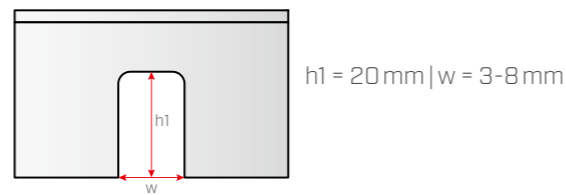

Item no.	Name
G-2920	mcut multi

mbend. THE MANIFOLD ONE.



The mbend. A manual bending device for optimum bending processes. And for precisely bent rules. Robust, variable and easy to handle. For rule thicknesses from 1.5 to 4 pt and rule heights from 8 to 50 mm. With an extensive range of standard bending forms. And a special scale for quick and accurate depth setting. The possibility of locking ensures precise repeatability.



Item no.	Name
G-2330	mbend



mcut|round. THE DEFINED ONE.

Simple and clever. That is the mcut|round. This special hand-held device rounds off the ends of flat or rotary creasing rules in a defined manner. In consistent quality, from the first to the last creasing rule. This prevents the paperboard from bursting at the creasing ends. The mcut|round cuts radii of 3 or 5 mm. Its cutting elements are wear-resistant, and repeated regrinding is possible. The mcut|round stands for high durability and best creasing performance.

Item no.	Name
G-2730	mcut round

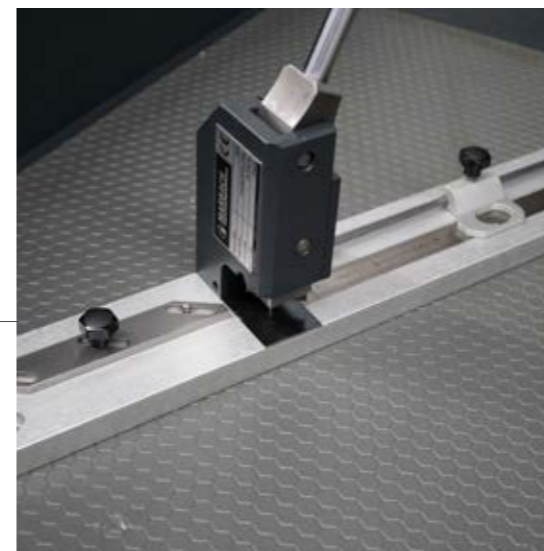

mcut|matrix. THE PRECISE ONE.

The mcut|matrix cuts creasing matrix. Fast, precise and safe. It is a flexible, ergonomic, very robust hand-held device that is perfectly adapted to the conditions in production. The infinitely variable gauge can be used for a wide variety of creasing geometries. Thus, it not only ensures exact cutting results, but also maximum flexibility. The special design of the mcut|matrix ideally reduces the required cutting force. For little effort when cutting creasing matrix.

Item no.	Name
G-2740	mcut matrix



mcut|notch-duo. THE TWIN.

The manual device mcut|notch-duo is a stair notcher of a special kind: two different notchers with varying widths (3-10 mm) in just one device. The manual gauge ensures correct positioning of the notches, even in series production. The mcut|notch-duo is very robust and has an excellent cutting ratio. The special cutting geometry ensures an easy and clean cut. With perfect results.

Item no.	Name
G-2901	mcut notch-duo

mbench|smart.

THE CLEVER ONE.



Item no.:	G-2180
Dimensions (lxwxh):	1,500x700x1,100 mm (1,500 mm)
Drawers:	5 pcs., width > 1,000 mm
Rear wall:	with 6 shelves
Work surface:	anti-slip rubberized surface
Wheels:	lockable heavy duty wheels

Maximum flexibility and efficiency: With the mobile repair workstation mbench|smart you are equipped for all situations. Its smooth-running heavy-duty wheels ensure safe and fast transport to its place of use. The optional equipment with the most important rule processing devices such as the hand bender mbend or the multifunctional device mcut|multi for cutting to length, notching and lipping makes it an indispensable companion in your production. There is plenty of space for your accessories in the 5 integrated drawers. The rear panel offers 6 shelves for different cutting rules, easily accessible via a central access opening.

mbench|smart. Your mobile companion for fast and flexible repair of your tools.

LED WORK LIGHT.

THE FLEXIBLE ONE.

High luminosity

Flexibly adjustable

Best visibility at the workplace

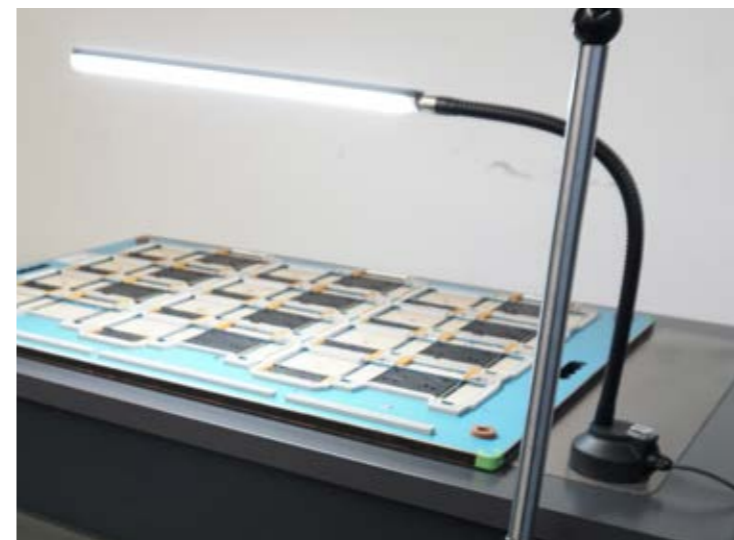

Our special LED work light provides optimum illumination of your tool processing surface. With its strong luminosity of 1,250 lumens, the LED work light is very bright. And it does so with low energy consumption. In addition, it is extremely flexible: because it can be magnetically attached to any place on your work table and also has an arm that can be adjusted in all directions. This means that the LED light can always be used to optimally illuminate the desired area. For the best visibility when processing your tools.

Item no.	Name
G-51115	LED work light
G-51117	Power supply unit LED work light



Item no.:	G-2181
Dimensions (lxwxh):	1,340x1,340x1,000 mm
Drawers:	9 pcs., width > 1,000 mm
Mounting plate:	700x1,000 mm
Work surface:	steel plate and anti-slip rubberized surface
Wheels:	lockable heavy duty wheels

mbench|pro.

THE UNIVERSAL ONE.

The mbench|pro is a professional assembly table for your production. It can be used in die making, for rework directly at the die-cutting machine, or in die preparation. It is larger than the mbench|smart. And even more versatile. A complete workstation with a flat mounting surface. In its 9 drawers you will have plenty of space for accessories and important equipment for processing your cutting dies. Of course, the mbench|pro can also be equipped with the most important rule processing devices. And just like the mbench|smart, it has smooth-running heavy-duty wheels for maximum mobility.

mbench|pro. Your mobile assembly table for maximum performance in your production.

Available as single position or complete system

In 6 different heights

Including shimfoils & rubber

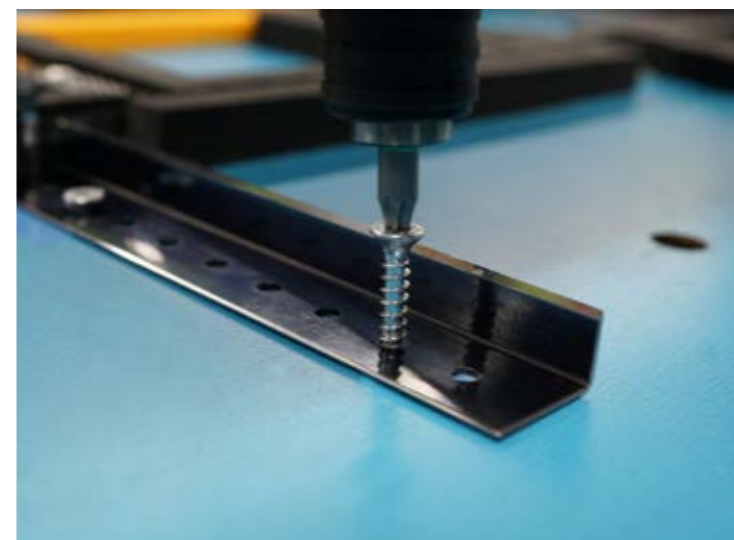

trimknife|multi.

THE SPECIAL ONE.

trimknife|multi. Screw-on separation knives for special requirements in 6 different heights. trimknife|multi is the solution when the waste separation knives of the tool need to be replaced or extended. Available as a single item (separation knives) or as a complete set with separation knives including shimfoils, fastening screws, rubber material as well as a suitable screwdriver incl. bit for a cordless screwdriver.



Item no.	Name
04355	trimknife multi

TOOLS.



Scissors

Different versions of scissors. To cut rubber easily and safely.

- combo-scissors, 190 mm length (13018)
- small scissors, 160 mm length (13109)

Item no.	Name
13018	combo scissors
13109	scissors small



Bevelling scissors

Special scissors to cut crease channels and rubber in the right angle. With exchangeable spare blades (PU = Pack of 5).

Item no.	Name
15639	bevelling scissors



Gripping pliers

Special gripper with tip for quick and easy removal of rules or rubber. Also suitable for narrowest areas.

Item no.	Name
06099	gripping pliers DIN ISO 9655



Aluminum hammer

Aluminum hammer with change heads. For assembly of rules in folding carton dies. Optimal for mpower cutting rules and for creasing rules.

Item no.	Name
08498	alu hammer Ø25 mm
00234	set change heads



Polyurethane hammer

Special polyurethane hammer for the assembly of rules in rotary corrugated board cutting dies. Robust, durable and for best force transmission. Very pleasant to handle due to its easy detachment from the rule.

Item no.	Name
08986	Ø50x125 mm 400 g
10071	Ø70x115 mm 710 g



Rawhide hammer

Hammer with rawhide head for assembly of rules in rotary corrugated board cutting dies. Very tough. Dampens the load with every stroke. For high demands.

Item no.	Name
08497	Ø45x90 mm; 260g
08730	Ø52x105 mm; 380g
08370	Ø70x122 mm; 700g



Pliers

Assembly pliers in different versions. Ideal for the assembly of cutting dies. In daily use at Marbach. The inexpensive alternative to rule pullers.

Item no.	Name
07067	assembly pliers
04902	assembly pliers long



marbaglue

Adhesive for applying rubber on cutting dies. Available in different versions depending on requirements: 06092 for flat paperboard dies, 06093 for rotary corrugated dies and 06094 for flat and rotary corrugated dies..

Item no.	Name
06092	plug cap (paperboard) 20g
06093	twist cap (corrugated board) 20g
06094	twist cap (corrugated board) 50g



Soft face hammer

Hammer with a special soft head and change heady (nylon).

In special design for the assembly of very sharp cutting rules in folding box and corrugated board cutting dies. Easily replaceable nylon spare heads available.

Item no.	Name
08366	soft face hammer Ø25 mm
08495	set change heads



Aluminum hammer

Hammer with aluminum head for mounting rules in folding box and corrugated board cutting dies. Optimally suited for mpower cutting rules and for creasing rules.

Item no.	Name
08498	40x75 mm; 250 g
08499	40x100 mm; 350 g



Adjustment fork

Adjustment fork for exact alignment of rules at the rule joints. Simple and quick. With impact protection.

Item no.	Name
10200	adjustment fork



DIEBOARD-MATERIAL.

Dieboards, made of high quality birch wood. With very uniform surface. Perfectly laserable. This is the base for your cutting die. In various sizes and thicknesses. Varnished or unvarnished. For flat cutting dies or rotary dies. The right solution for every requirement.

Flat plywood

Item no.	Dimensions [mm]	Thickness [mm]
10804	1,250x1,250	6.5 varnished
58023A	1,525x1,525	9.0 varnished
58038H	1,500x2,150	12.0 varnished
58039H	1,200x1,600	15.0 unvarnished
58040H	1,500x2,100	15.0 unvarnished
58016A	1,120x1,525	18.0 unvarnished

other sizes and thicknesses on request

Rotary half shells

Item no.	Ø [mm]	L [mm]	W [mm]
58034	13	1,900	177
58027H	13	1,700	270
58028H	13	2,100	270
58026	13	2,100	381
58049	13	2,000	487
58026H	13	2,100	487
58025H	13	2,500	487

other sizes and diameters on request



CUTTING RULES. PIECE BY PIECE. OR BY THE COIL.



For perfect die cutting results, the rule material is of great importance. The selection depends on your individual requirements.

Marbach has an extensive portfolio of rule materials. For every application and for every need. Whether short or long runs. No matter what needs to be die cut: Coated or uncoated material. Plastic or foam. The right rule for every application. Meter pcs. (all item numbers with "M" at the end) for manual and roll material for machine processing.



mpower. The original.

A standard developed by Marbach. The mpower cutting rule. The trick: a rounded cutting tip that compensates tolerances and eliminates angel hair. Which is almost immune to overpressure. For the shortest make-ready times. Simply for maximum die cutting performance from the first to the last sheet.

Item no.*	Thickness	Chamfer	PU/Roll
01212	2pt	center bevel	100 m
01977	2pt	center bevel 42°	100 m
01986	3pt	center bevel	75 m
01252	3pt	long center bevel	75 m

*item also available by the meter

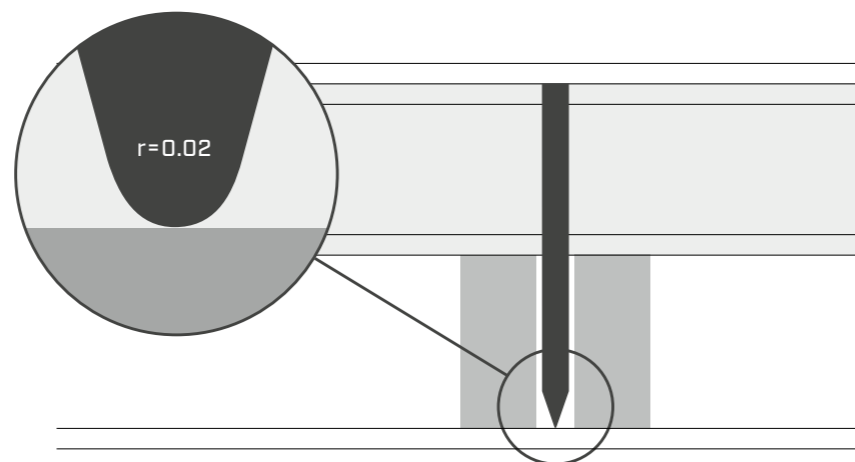

Cutting edge

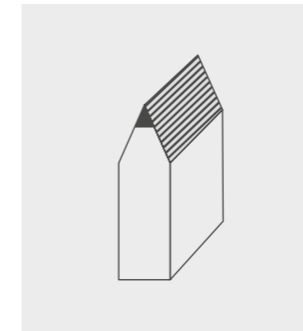

Shaved cutting edge

Precisely processed. Reliable over many years. The standard.

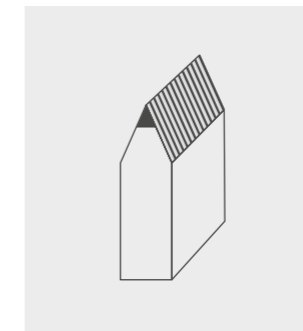

Ground cutting edge

Precise cutting edges. Reduced cutting pressure. Penetrates easily through the material.

Winding direction

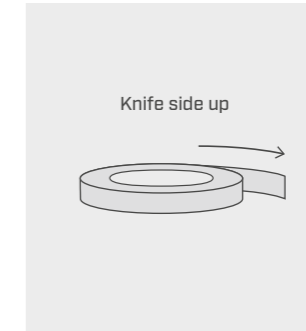

Clockwise

The correct winding direction. For your bending machine. And your application. Clockwise.

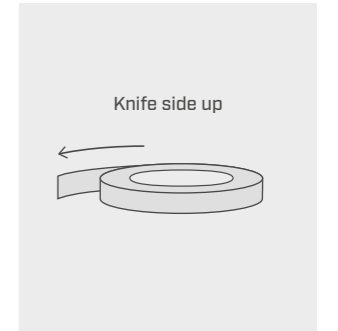

Anti-clockwise

The correct winding direction. For your bending machine. And your application. Anticlockwise.

Cutting edge geometries

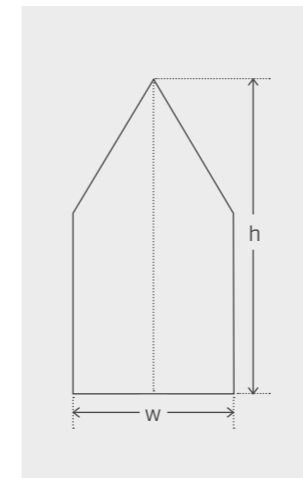

0 - center bevel

The standard for cutting paperboard. Also available as side bevel.

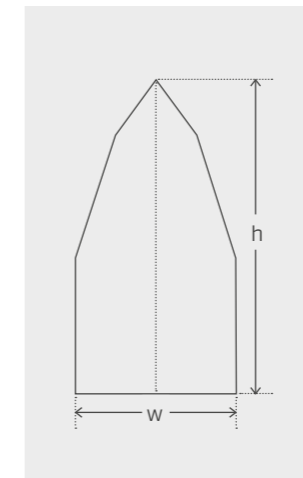

D4 - long center bevel

For thick materials. The standard for corrugated board. Also available as side bevel.

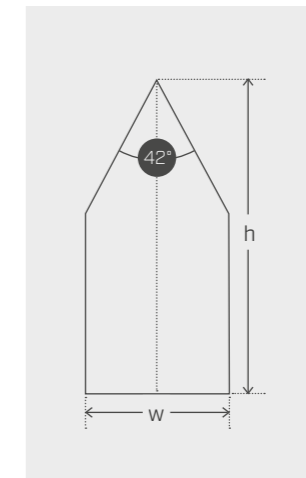

42° cutting angle

The cutting rule penetrates easily into the material. Lower cutting pressure is needed. The standard in America.

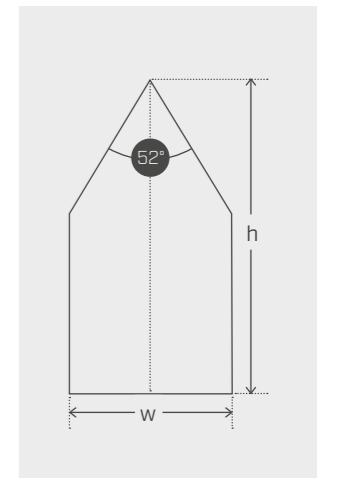

52° cutting angle

The cutting rule is very robust. It has a long lifespan. The standard in Europe and Asia.

mhard.

THE HARDENED ONE.



mhard has a hardened edge. The advantages of mhard: it distinguishes itself by providing a long lifespan and high stability. With little abrasion. The mhard is a great fit for medium runs.

Item no.*	Thickness	Chamfer	PU/Roll
00985	2pt	center bevel	100 m
01045	2pt	long center bevel	100 m
02505	3pt	center bevel	75 m
01073	3pt	long center bevel	75 m

*item also available by the meter

mpower|s.

THE DURABLE ONE.



mpower|s. For very special requests. mpower|s has the same cutting geometry as mpower. mpower|s is very hard and therefore resistant to abrasive wear and tear. This makes it very durable. Its main use: die-cutting of cosmetic packaging and corrugated board.

Item no.*	Thickness	Chamfer	PU/Roll
10084	2pt	center bevel	100 m
10085	3pt	long center bevel	75 m

*item also available by the meter

mgold.

THE SPECIAL ONE.



The special cutting rule mgold. Impressive hardness. mgold has a 42° cutting edge. Therefore it is very sharp and works perfectly for cut scores. mgold is optimal for long runs and critical material. Also for cutting metallized cartons and thin metal foils.

Item no.*	Thickness	Chamfer	PU/Roll
20010	2pt	center bevel; 55 HRC	100 m
20011	2pt	center bevel; 60 HRC	100 m

*item also available by the meter

mgold|+.

THE VERY SPECIAL ONE.



Like its little brother mgold, this cutting rule has a 42° edge. Due to this and its special coating, it is not only very sharp but also very hard and therefore suitable for the highest demands. It is extremely resistant to abrasion and is thus used when maximum tool life is required for die-cutting critical materials.

Item no.*	Thickness	Chamfer	PU/Roll
20020	2pt	center bevel; 60 HRC	100 m

*item also available by the meter



mhard|r.

Special rotary cutting rule for processing corrugated board. It protects the counter material and ensures waste-free die cutting and best productivity. Available in different height and diameter versions.

Item no.	Name	PU
08430	1.42x25.40 mm curved Ø487 mm; 8 TPI	30.5 m
08431	1.42x25.40 mm straight; 8 TPI	30.5 m
08535	1.42x24.60 mm straight; 8 TPI	30.5 m
08536	1.42x24.60 mm curved Ø487 mm; 8 TPI	30.5 m
08533	1.42x23.80 mm straight; 8 TPI	30.5 m
08534	1.42x23.80 mm curved Ø487 mm; 8 TPI	30.5 m



Perforation rule.

Rotary perforation rule for corrugated paperboard packaging. Ensures exact and easy folding of the blanks. And functional opening mechanisms.

Name
rotation-perforation rule; 1.42x23.8 mm; different gaps/cuts
rotation-perforation rule; 1.42x24.6 mm; different gaps/cuts
rotation-perforation rule; 1.42x25.4 mm; different gaps/cuts
Other combinations on request.



mhard|r+.

New generation of rotary cutting rules. Due to its unique knife hardening and its special corrugated grinding technology, the mhard|r+ cuts the corrugated board very easily. For a smooth die-cutting result – even with high grammages and heavy corrugated board.

Item no.	Name	PU
52911	1.42x25.40 mm straight; 8 TPI	30.5 m
52914	1.42x25.40 mm curved Ø487 mm; 8 TPI	30.5 m
52916	1.42x25.40 mm curved Ø645 mm; 8 TPI	30.5 m
52913	1.42x26.40 mm straight; 8 TPI	30.5 m
52917	1.42x26.40 mm curved Ø487 mm; 8 TPI	30.5 m
52912	1.42x26.40 mm curved Ø645 mm; 8 TPI	30.5 m



Creasing rule.

Standard creasing rule for creasing thin corrugated board. For good creasing results. And functioning folding mechanisms.

Item no.	Name	PU
08208	22.80x1.42 mm curved Ø487 mm	30.5 m
08269	22.10x1.42 mm curved Ø487 mm	30.5 m
01466	23.00x1.42 mm	45.7 m
01467	23.10x1.42 mm	45.7 m



Sawtooth rule.

Rotary cutting rule in special sawtooth version for processing corrugated board. Available in straight and curved versions.

Item no.	Name	PU
10682	1.42x25.80 mm straight; 20 TPI	40.0 m
09404	1.42x25.80 mm curved Ø487; 20 TPI	30.5 m



Reduced body creasing rule.





Rotary creasing rule in special version for heavy corrugated board types. And double flute. Provides best results with 180° folds.

Item no.	Name	PU
08422	22.10x3.00x1.42 mm curved Ø487 mm; flat head	30.5 m
08578	23.00x3.00x1.42 mm curved Ø487 mm; flat head	30.0 m
08669	22.60x3.00x1.42 mm straight; flat head	25.0 m
08468	23.00x3.00x1.42 mm straight; flat head	25.0 m

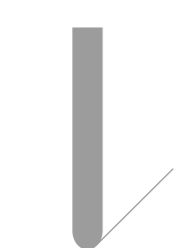
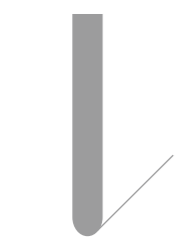
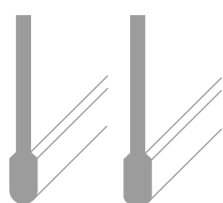

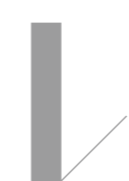
Creasing rules.

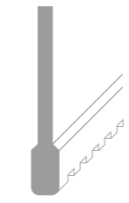
	Item no.	Thickness	Height	PU
 2pt (0.71mm)	01359	2pt	23.20 mm	20 m
	01360	2pt	23.25 mm	20 m
	01361	2pt	23.30 mm	100 m
	01363	2pt	23.40 mm	100 m
	01365	2pt	23.50 mm	100 m
	01366	2pt	23.60 mm	100 m
	01368	2pt	23.80 mm	20 m
	on request	2pt	22.00-23.90 mm	20 m
 3pt (1.05mm)	01425	3pt	22.60 mm	20 m
	01428	3pt	22.80 mm	20 m
	01405	3pt	23.00 mm	20 m
	01407	3pt	23.20 mm	20 m
	01408	3pt	23.30 mm	60 m
	01409	3pt	23.40 mm	50 m
	01410	3pt	23.50 mm	68 m
	01411M	3pt	23.60 mm	75 m
on request	3pt	21.50-23.90 mm	20 m	
 4pt (1.42mm)	01306	4pt	21.70 mm	20 m
	01314	4pt	22.60 mm	20 m
	01483	4pt	22.80 mm	20 m
	01466	4pt	23.00 mm	20 m
	01468	4pt	23.20 mm	20 m
	on request	4pt	21.50-27.00 mm	20 m
 WRT WFT	on request	3/6pt	22.20-23.40 mm WRT/WFT	20 m
	on request	3/8pt	22.20-23.40 mm WRT/WFT	20 m

	Item no.	Thickness/ Name	Height x Thickness [mm]	PU
 Crease TT 2pt(0,71mm)	50268	TT	23.60 mmx2pt	20 m
	50267	TT	23.70 mmx2pt	20 m
 Crease NT 2pt 2/1pt (0,71/0,36 mm) 2/1,5pt (0,71/0,53 mm)	01544M	NT 2/1pt	23.00 mmx2pt	20 m
	01545M	NT 2/1pt	23.10 mmx2pt	20 m
	01546M	NT 2/1pt	23.20 mmx2pt	20 m
	01548M	NT 2/1pt	23.30 mmx2pt	20 m
	01562	NT 2/1pt	23.85 mmx2pt	20 m
	04165	NT 2/1,5pt	23.60 mmx2pt	20 m
	01527	NT 2/1,5pt	23.85 mmx2pt	20 m
	08860	Headcrease	22.80 mmx4/8pt	20 m
 Headcrease	10472	Headcrease	23.00 mmx4/8pt	20 m
	08722	Headcrease	22.60 mmx4/8pt	20 m
	50343	Headcrease	23.00 mmx4/8pt	20 m
 Multcrease	50312	Multcrease	22.80 mmx4/8pt	20 m
	50311	Multcrease	23.00 mmx4/8pt	20 m
	50307	Multcrease	22.60 mmx4/8pt	20 m
	50308	Multcrease	22.80 mmx4/8pt	20 m
	50315	Multcrease	23.00 mmx4/8pt	20 m
 Wave crease	01168	Wave crease	22.40 mmx3pt	20 m
	01166	Wave crease	22.60 mmx3pt	20 m
	01165	Wave crease	22.80 mmx3pt	20 m
	01164	Wave crease	23.00 mmx3pt	20 m
	01163	Wave crease	23.20 mmx3pt	20 m

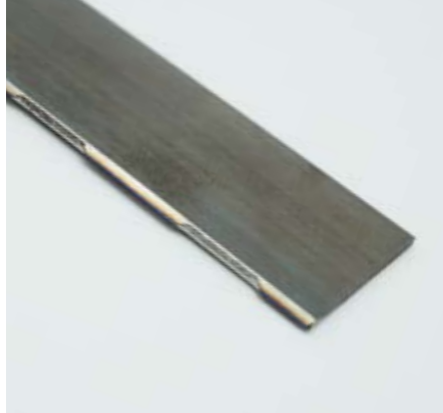

Crease-cut combination rules. PERFORATION RULES.

Perforation and combination perforation rules are available in different versions. In the thicknesses 2pt, 3pt or 4pt. All rules are available by the meter. For completely individual perforations.

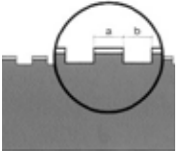
Perforation	Thickness	PU
	2pt	20m
	3pt	20m
	4pt	20m

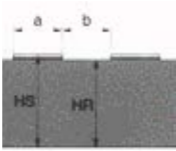
Combo-perforation	Thickness	PU
	2pt	20m
	3pt	20m
	4pt	20m



Tear perforation rules.

Tear perforation rules are available in different versions. Left or right. In thicknesses of 2pt or 3pt. For tear open mechanisms that work. All rules are available by the meter.

Fishbone rule

Item no.	Thickness	Height	PU
10549M	2pt 3pt	23.80mm	20m
10548M	2pt 3pt	23.80mm	20m
10547M	2pt 3pt	23.80mm	20m
10540M	2pt	23.80mm	20m

further tear perforation rules on request

Sharklinie

Item no.	Thickness	Height	PU
01446M	2pt	23.80mm	20m
01433M	3pt	23.80mm	20m
01892M	3pt	23.80mm	20m
01435M	3pt	23.80mm	20m

further tear perforation rules on request

Wave rule.

Special rules with waved edge. This is used when the packaging should be equipped with safe cutting edges. For heightened safety when finished products are assembled.

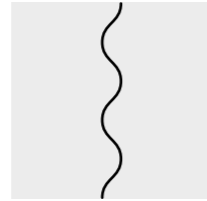
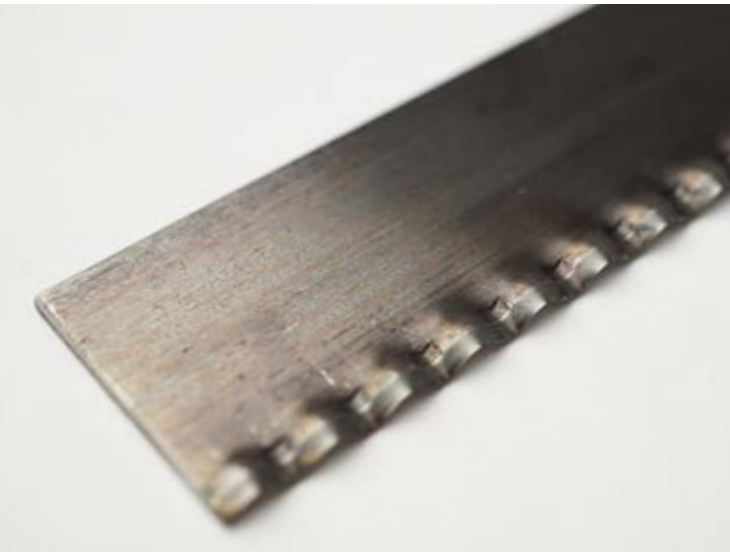

Item no.	Type	Thickness	Height	PU
01102	2.0mm	3pt	23.80mm	20m
01102M	2.0mm	3pt	23.80mm	20m
01101	3.5mm	3pt	23.80mm	20m
01101M	3.5mm	3pt	23.80mm	20m
01162	5.0mm	3pt	23.80mm	20m
01162M	5.0mm	3pt	23.80mm	20m

Special geometric rules.

Further development of the wave rule for flat tools. Optimal cutting edge protection for users. Resulting in highest safety when assembling finished products. The cutting result is similar to a rotary cut packaging with mhardjr.



Item no.	Name	PU
01121	1.05x23.80mm	20m

Deckle edge rule.

Special rule with edge for stamped outer contour. When cut with a deckle edge rule the produced packaging gets an attractive look and convinces with its aesthetic charisma.

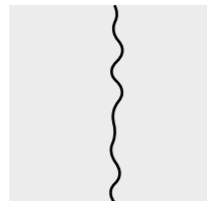
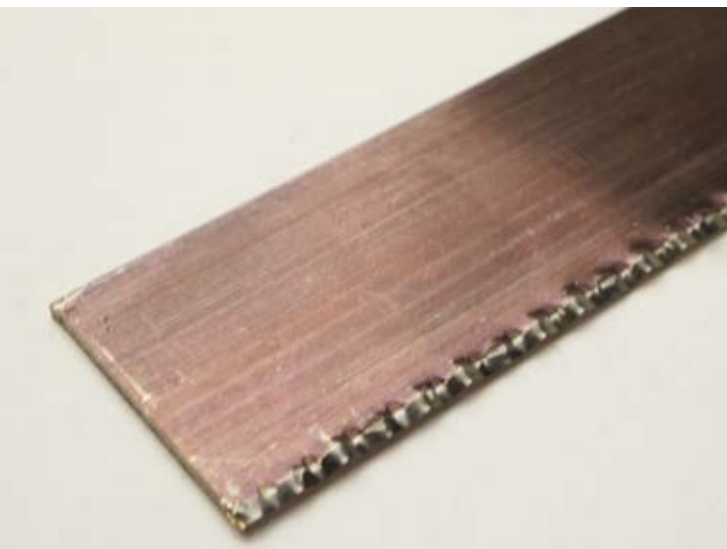

Item no.	Name	PU
01832M	1.05x23.80mm	20m
01934M	1.05x23.80mm	20m

Special rule.

A special cutting knife for optimal reverse cutting of the paperboard material. Highly precise and very sharp. For tear mechanisms that not only work perfectly, but are also visually attractive.



Item no.	Name	PU
01995M	reverse cutting plate 12x 1,000 mm/ 0.8 mm/ 0.3 mm Angle 70°	ab 10m
01997M	reverse cutting plate-perforations	on request



HOLE PUNCHES. BENT CUTTING CIRCLES.

To cut perfect round circles, there are several options: Bent cutting circles or hole punches. For small diameters up to 10 mm, ready-made hole punches are the perfect solution. For diameters of 11 mm and more, we recommend bent mpower cutting circles made of hardened steel. With brass ejector and adjustable pressure spring.

Bent cutting circles	Item no.	Ø	Height
	02069	11	23.80 mm
	02022	12	23.80 mm
	02024	13	23.80 mm
	02026	14	23.80 mm
	02028	15	23.80 mm
	02030	16	23.80 mm
	02032	17	23.80 mm
	02870	18	23.80 mm
	02871	19	23.80 mm
	02865	20	23.80 mm
	02864	21	23.80 mm
	02863	22	23.80 mm
	02872	23	23.80 mm
	02862	24	23.80 mm
	02860	25	23.80 mm
	02866	26	23.80 mm
	02873	27	23.80 mm
	02867	28	23.80 mm
	02861	30	23.80 mm
	02875	31	23.80 mm
	02868	32	23.80 mm
	02874	34	23.80 mm
	02869	35	23.80 mm



Finished parts mpower

Hole punches Types	Item no.	Ø	Height
	02172	3	23.80 mm
	01145	4	23.80 mm
	01147	5	23.80 mm
	01149	6	23.80 mm
	01173	7	23.80 mm
	01177	8	23.80 mm
	01179	9	23.80 mm
	01183	10	23.80 mm
	*on request available up to 23 mm		
	02799	1	23.80 mm
	02801	2	23.80 mm
	02803	3	23.80 mm
	02805	4	23.80 mm
	02807	5	23.80 mm
	02809	6	23.80 mm
	02811	7	23.80 mm
	02813	8	23.80 mm
	02815	9	23.80 mm
	02817	10	23.80 mm
	**on request available up to 20 mm		

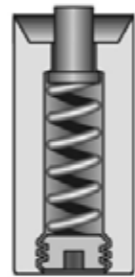

FB*

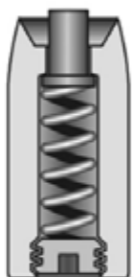

G**

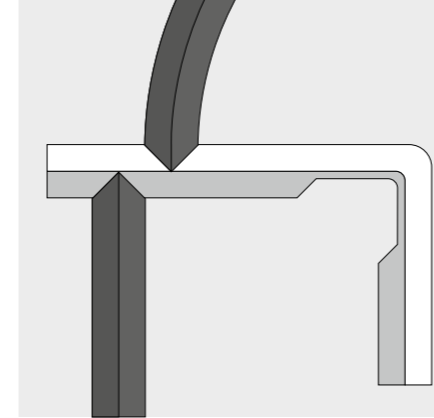

SAFETY CUTS.

Safety cuts ensure secure closure of folding boxes. With strip steel elements equipped with a special bend-free grind, their execution in the packaging always succeeds. This is because it ensures an exact rule height, even at a bent angle. All sizes are available in left and right versions.

Item no.	Description	Dimensions (L x W)	Bending site	PU
02905	Safety cut no. 5	5x5 mm	right	3,000 pcs.
02925	Safety cut no. 5	5x5 mm	left	3,000 pcs.
02906	Safety cut no. 6	6x5 mm	right	3,000 pcs.
02926	Safety cut no. 6	6x5 mm	left	3,000 pcs.
02907	Safety cut no. 7	7x5 mm	right	2,100 pcs.
02927	Safety cut no. 7	7x5 mm	left	2,100 pcs.
02908	Safety cut no. 8	8,5x5 mm	right	1,900 pcs.
02928	Safety cut no. 8	8,5x5 mm	left	1,900 pcs.
02909	Safety cut no. 9	10x5 mm	right	1,600 pcs.
02929	Safety cut no. 9	10x5 mm	left	1,600 pcs.
02910	Safety cut no. 10	11x5 mm	right	1,500 pcs.
02930	Safety cut no. 10	11x5 mm	left	1,500 pcs.
02911	Safety cut no. 11	12x5 mm	right	1,300 pcs.
02931	Safety cut no. 11	12x5 mm	left	1,300 pcs.







RUBBERING PAPERBOARD. FORM PARTS & PROFILES FOR FLAT DIE-CUTTING.

When die-cutting paperboard, the rubbering plays an important role in the die-cutting process. Different cartonboard materials require different rubbering. For optimum functionality, the rubbering must be individually adapted to the requirements of the job. The rubbering materials used by Marbach are diverse. And all from carefully selected suppliers. Many even produced exclusively for us. This ensures a long service life and best functionality.

Form parts

Item no.	Name	Dimensions	Hardness	Color
03044CF-07	moose rubber	7x7x500 mm	35 shore	grey
03007CF-07	Vulkollan®	7x7x500 mm	40 shore	yellow
03014CF-07	Vulkollan®	7x7x500 mm	55 shore	yellow
03074CF-07	cellrubber	7x7x500 mm	15 shore	black
05126CF-02	flexpower h hard	7x7x500 mm	40 shore	black

Profiles

Item no.	Name	Dimensions	Hardness	Color	Profile
03431	profile cork	7x7x630 mm	65 shore	brown	
03429	profile rubber NRB	7,3x8x1,000 mm	70 shore	white	
03420	profile cork; R4,5 strongly rounded	7x7,3x640 mm	65 shore	brown	
03421	profile cork; T-profile rounded	7x5x640 mm	65 shore	brown	
03139	profile cork; CD-profile rounded	7x7x630 mm	65 shore	brown	

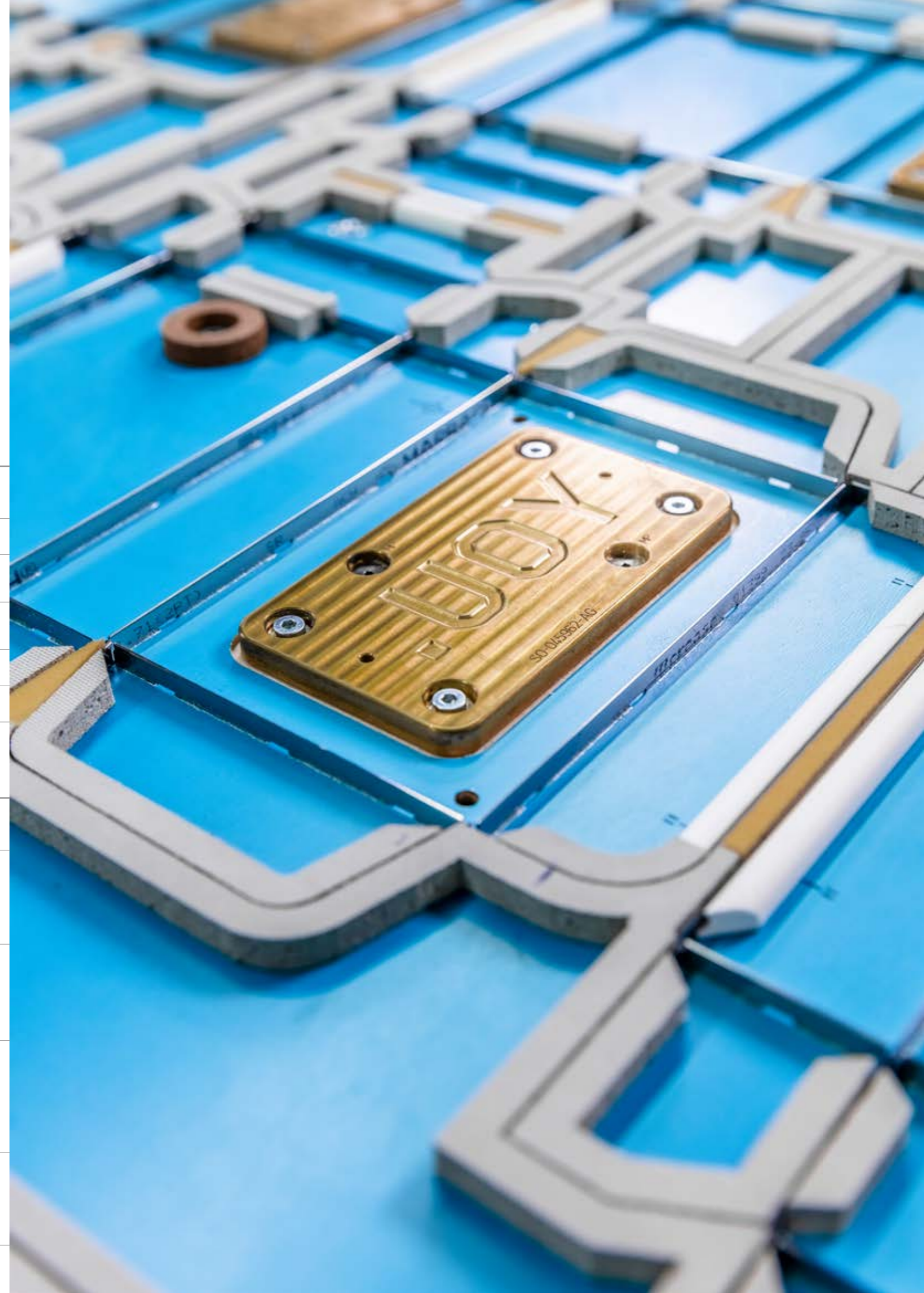



CORRUGATED BOARD RUBBERING. FORM PARTS FOR FLAT DIE-CUTTING.

Flat die-cutting of corrugated board requires a rubbering perfectly matched to the material. Our extensive rubber range ensures productivity in packaging production. As sheet material, profiles or form parts.

Form parts

Item no.	Name	Dimensions	Hardness	Color
15819CF-10	cellrubber softpower	10x10x500 mm	20 shore	black
15819CF-10A	cellrubber softpower	10x10x500 mm	20 shore	black
03345CF-13	cellrubber softpower	13x13x500 mm	20 shore	black
03345CF-13A	cellrubber softpower	13x13x500 mm	20 shore	black
05089CF-10	flexpower s soft	10x10x500 mm	20 shore	white
05089CF-10A	flexpower s soft	10x10x500 mm	20 shore	white
05094CF-13	flexpower s soft	13x13x500 mm	20 shore	white
05094CF-13A	flexpower s soft	13x13x500 mm	20 shore	white
05097CF-10	flexpower h hard	10x10x500 mm	40 shore	white
05098CF-13	flexpower h hard	13x13x500 mm	40 shore	white
20013CF-10	elastomer PUR	10x10x658 mm	20 shore	yellow
20005CF-14	elastomer PUR	14x14x658 mm	20 shore	yellow

CORRUGATED BOARD RUBBERING. PROFILES FOR FLAT DIE-CUTTING.

Profiles

Item no.	Name	Dimensions	Hardness	Color	Profile
03518	C3 flat	7x12.5x1,000 mm	60 shore	black	
03501	C3	7.5x12.5x1,000 mm	65 shore	red	
09399	profile rubber hard	9.1/7x5x1,000 mm	75 shore	white	
09398	profile rubber hard	8.5/7.5x5x1,000 mm	75 shore	white	
09397	profile rubber hard	11/9x5x1,000 mm	75 shore	white	
03512	profile rubber easy crease	8x15x600 mm	20 shore	black	
08162	profile rubber easy crease	9x15x600 mm	55 shore	black	
08161	profile rubber easy crease	11x15x600 mm	55 shore	black	
50185	C 14 Soft	14x12.5x1,000 mm	25 shore	red	
50185	G 2.5 - C11 soft red	11x12.5x1,000 mm	25 shore	red	
08670	C 9.5	9.5x10.5x600 mm	60 shore	black	
10969	profile Vulkollan®	14x14x530 mm	40 shore	yellow	
03450	profile Vulkollan®	10x10x480 mm	40 shore	yellow	
03542	wedge profile Vulkollan®	12x16x500 mm	40 shore	yellow	
03543	wedge profile Vulkollan®	14x16x500 mm	40 shore	yellow	
09241	clean-cut rubber	9x12 mm	55 shore	black	
09240	clamping strip for clean-cut rubber	17x4.4x1,000 mm		clear	



CORRUGATED BOARD RUBBERING.

FORM PARTS FOR ROTARY DIE-CUTTING.

When rotary die cutting corrugated board, the ejector function is particularly important. The decisive factor is which rubber should be used in which position. We have an extensive range of rubber materials. The choice is yours.

Form parts



Item no.	Name	Dimensions	Hardness	Color
15821C-1230	cellrubber softpower	12x12x30 mm	20 shore	black
15821C-1240	cellrubber softpower	12x12x40 mm	20 shore	black
15822C-1430	cellrubber softpower	14x14x30 mm	20 shore	black
15822C-1440	cellrubber softpower	14x14x40 mm	20 shore	black
15822CF-14	cellrubber softpower	14x14x500 mm	20 shore	black
15822CF-14A	cellrubber softpower	14x14x500 mm	20 shore	black
05095C-1230	flexpower s soft	12x12x30 mm	20 shore	white
05095C-1240	flexpower s soft	12x12x40 mm	20 shore	white
05096C-1430	flexpower s soft	14x14x30 mm	20 shore	white
05096C-1440	flexpower s soft	14x14x40 mm	20 shore	white
05109CF-25A	flexpower s soft	7x25x1,000 mm	20 shore	white
05089CF-25	flexpower s soft	10x25x1,000 mm	20 shore	white
05095CF-12	flexpower s soft	12x12x500 mm	20 shore	white
05096C-14	flexpower s soft	14x14x500 mm	20 shore	white
05038C-1630	flexpower s soft	16x16x30 mm	20 shore	white
05126C-0730	flexpower h hard	7x7x30 mm	40 shore	white
05107CF-16	flexpower h hard	16x16x500 mm	40 shore	white



CORRUGATED BOARD RUBBERING.

PROFILES FOR ROTARY DIE-CUTTING.

Profiles

Item no.	Name	Dimensions	Hardness	Color	Profile
09775M	cell Vulkollan® profil RG 50	10x12x500 mm	35 shore	yellow	
10940	crease profile rubber	6.35x20 mm	70 shore	black	
10941	crease profile rubber	6.99x20 mm	70 shore	black	
10942	crease profile rubber	7.50x20 mm	70 shore	black	
10943	crease profile rubber	8.50x20 mm	70 shore	black	
10945	crease profile rubber	9.65x20 mm	70 shore	black	
10947	crease profile rubber	9.40x20 mm	70 shore	black	
10948	crease profile rubber	8.00x20 mm	70 shore	black	
10969	profil Vulkollan®	14x14x530 mm	40 shore	black	



RUBBER PLATES. CORRUGATED BOARD AND PAPERBOARD.

Item no.	Name	Dimensions	Hardness	Color	PU
15883	cellrubber softpower	7x500x1,200 mm	20 Shore	black	1 plate
15874	cellrubber softpower	8x500x1,200 mm	20 Shore	black	1 plate
15819	cellrubber softpower	10x500x1,200 mm	20 Shore	black	1 plate
15819F	cellrubber softpower	10x500x1,200 mm	20 Shore	black	1 plate
15821	cellrubber softpower	12x500x1,200 mm	20 Shore	black	1 plate
03345	cellrubber softpower	13x500x1,200 mm	20 Shore	black	1 plate
03345F	cellrubber softpower	13x500x1,200 mm	20 Shore	black	1 plate
15882	cellrubber softpower	14x500x1,200 mm	20 Shore	black	1 plate
15823	cellrubber softpower	16x500x1,200 mm	20 Shore	black	1 plate
15058	cellrubber softpower	18x500x1,200 mm	20 Shore	black	1 plate
05109	flexpower s soft	7x500x1,000 mm	20 Shore	white	1 plate
05089	flexpower s soft	10x500x1,000 mm	20 Shore	white	1 plate
05089F	flexpower s soft	10x500x1,000 mm	20 Shore	white	1 plate
05095	flexpower s soft	12x500x1,000 mm	40 Shore	white	1 plate
05094	flexpower s soft	13x500x1,000 mm	20 Shore	white	1 plate
05094F	flexpower s soft	13x500x1,000 mm	20 Shore	white	1 plate
05096	flexpower s soft	14x500x1,000 mm	20 Shore	white	1 plate
05038	flexpower s soft	16x500x1,000 mm	20 Shore	white	1 plate
05126	flexpower h hard	7x500x1,000 mm	40 Shore	white	1 plate
05097	flexpower h hard	10x500x1,000 mm	40 Shore	white	1 plate
05097F	flexpower h hard	10x500x1,000 mm	40 Shore	white	1 plate
05098F	flexpower h hard	13x500x1,000 mm	40 Shore	white	1 plate
05098	flexpower h hard	13x500x1,000 mm	40 Shore	white	1 plate

Item no.	Name	Dimensions	Hardness	Color	PU
05099	flexpower h hard	14x500x1,000 mm	40 Shore	white	1 plate
05107	flexpower h hard	16x500x1,000 mm	40 Shore	white	1 plate
05108	flexpower h hard	18x500x1,000 mm	40 Shore	white	1 plate
20013	Elastomer PUR	10x380x658 mm	20 Shore	yellow	1 plate
20000	Elastomer PUR	12x380x658 mm	15 Shore	sand	1 plate
20014F	Elastomer PUR	13x380x658 mm	20 Shore	yellow	1 plate
03007F	Vulkollan®	7x250x500 mm	45 Shore	yellow	1 plate
03014F	Vulkollan®	7x250x500 mm	55 Shore	yellow	1 plate
03207	Vulkollan®	7x500x250 mm	35 Shore	yellow	1 plate
03210	Vulkollan®	10x500x250 mm	35 Shore	yellow	1 plate
03007	Vulkollan®	7x500x250 mm	45 Shore	yellow	1 plate
03010	Vulkollan®	10x500x250 mm	45 Shore	yellow	1 plate
03014	Vulkollan®	7x500x250 mm	55 Shore	yellow	1 plate
03260	Vulkollan®	10x500x250 mm	55 Shore	yellow	1 plate
03044F	moose rubber	7x500x1,000 mm	35 Shore	grey	1 plate
03122	rubber cork	7x500x1,000 mm	65 Shore	brown	1 plate
03123	rubber cork	10x500x1,000 mm	65 Shore	brown	1 plate
03552	Aclathan®	9.2x500x250 mm	65-70 Shore	amber	1 plate
03552F	Aclathan®	9.2x500x250 mm	65-70 Shore	amber	1 plate
32005	elastopower	10x500x500 mm	20 Shore	yellow	1 plate
32006	elastopower	10x500x500 mm	40 Shore	orange	1 plate
32011	elastopower	12x500x500 mm	15 Shore	white	1 plate
32007	elastopower	14x500x500 mm	15 Shore	white	1 plate
32004	elastopower	16x500x500 mm	45 Shore	brown	1 plate

SMALL COMPONENTS.



T-nuts

T-nuts for die fixing in the counter chase. With and without thread.

PU = 500 pcs.

Item no.	Name
14045	M10x13 mm
04988	M8x11 mm
14039	M6x12 mm
14051	M6x9 mm
04981	M6x14 mm
14052	M5x12 mm
04986	M5x18 mm
04993	M4x12 mm
04989	M4x8 mm



Speed mounts

Elements for attaching rotary cutting dies to the die cutting cylinder. For a secure connection. In two different versions. Round hole for precise positioning. Slotted hole for flexible use. In aluminum version for even more stability.

PU = 100 pcs.

Item no.	Name
08548	round hole
08545	slotted hole



Lock-up chase screws

Countersunk head screws for fast mounting of the cutting die in the cutting chase. Available in sizes M5 (for corrugated board) and M4 (for paperboard).

PU = 100 pcs.

Item no.	Name
14251	M5x20 mm
14366	M4x20 mm
14367	M4x18 mm



Normal perfatypes

PU = 25 pcs.

Item no.	Name
08396	perfatype -
08347	perfatype /
08301	perfatype 0
08302	perfatype 1
08303	perfatype 2
08304	perfatype 3
08305	perfatype 4
08306	perfatype 5
08307	perfatype 6
08308	perfatype 7
08309	perfatype 8
08321	perfatype A
08322	perfatype B
08323	perfatype C
08324	perfatype D
08325	perfatype E
08326	perfatype F
08327	perfatype G
08328	perfatype H
08329	perfatype I
08330	perfatype J
08331	perfatype K
08332	perfatype L
08333	perfatypem
08334	perfatype N
08335	perfatype O
08336	perfatype P
08337	perfatype Q
08338	perfatype R
08339	perfatype S
08340	perfatype T
08341	perfatype U
08342	perfatype V
08343	perfatype W
08344	perfatype X
08345	perfatype Y
08346	perfatype Z



Special perfatypes

Special perfatype "RESY" label and "green point" label. For insertion into the cutting die. For rotation with notch on the back.

Item no.	Name
07051	RESY label
07065	mini RESY label
08368	green point label



Perfatype mounting rail

Mounting rails for perfatypes. Fast exchange of digits. The right rail for every kind of perfatype.

Item no.	Name
55600	green for type 3.0
55601	red for type 1.8
55602	blue for type 2.5
55603	black for type 3.5



Corner protection

Special elements to protect the edges of the tool. For a long lifespan. And to ensure that the tool slides into your customer's machine.

PU = 100 pcs.

Item no.	Name
09226	18 mm
09225	15 mm
09200	12 mm



Center notch reinforcement

Plastic elements that prevent the notch of your cutting die from getting loose. And thus to ensure dimensional stability and fast and precise tool positioning. Permanently and safe.

PU = 100 pcs.

Item no.	Name
07479	center reinforcement black



Mini perfatypes

Perforation marks for numbering of ups.

PU = 25 pcs.

Item no.	Name
19300	perfatype 0
19301	perfatype 1
19302	perfatype 2
19303	perfatype 3
19304	perfatype 4
19305	perfatype 5
19306	perfatype 6
19307	perfatype 7
19308	perfatype 8



Handles for rotary dies

Special handles for rotary half-shells. For optimized handling and higher work safety.

PU = 100 pcs.

Item no.	Name
42411	plastic, blue



Quick-release clamps

Quick locking system for rotary machines. For reduced set-up times.

PU = 50 pcs.

Item no.	Name
08348	∅487.3 mm
08349	∅366.2 mm
08351	∅270.2 mm
09617	∅240.9 mm
08450	∅177.0 mm
03270	washers

BRAILLE.



Braille females

Standard marbabraille females in different versions. As a counterpart to marbasteel male embossings. For optimal shaping of braille dots. And an optimal braille result.

on request

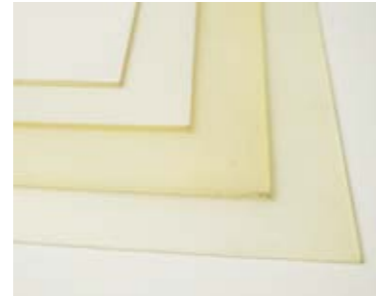

Elastomer segments

Elastic base as raw material. To be cut to size. For elastic embossing.

Item no.	Dimensions
09789	480x250x1.45 mm
09790	480x250x1.40 mm
09791	160x300x1.05 mm
09792	160x300x1.55 mm



Screws and pins

Fixing elements for marbabraille females on the cutting die.

PU = 100 pcs.

Item no.	Name
14236	lens head screw M 3x5
06607	rectangular bolt 5x5x19.50 mm



Shim foils

Pressure-resistant foils in defined thicknesses. For accurate and fast make-ready.

PU = 50 m Roll

Item no.	Name
00670	0.05x600 mm
00673	0.10 x610 mm
00671	0.20x600 mm



Adhesive foils

Double-sided adhesive film for lamination. For various purposes of application.

Item no.	Name
44011	0.10 mmx25 m
44101	0.13mmx50 m
44012	0.20 mmx10 m
44103	0.25 mmx10 m
00586	magnetic foil 0.65x615 mmx30 m



msteel blanks

The perfect material for the production of braille patrices. Braille dots are inserted into a sheet metal blank using the msteel machine. Fast and safe. Inscriptions can also be engraved.

Item no.	Name
83070	0.40x465x42.9 mm; 4-line; Hard nickel-plated
83071	0.40x467.75x42.9 mm; 4-line; Stainless steel
83072	0.40x465x52.9 mm; 5-line; Hard nickel-plated



STEEL AND WOODEN RAILS.

Wooden rails multiplex natural, lower part stabilization

Name	Item no.	Application	Version	PU
25 mm	L-HLZ25	Paperboard processing machines	15 mm 18 mm	50 pcs.
35 mm	L-HLZ35	Paperboard processing machines	15 mm 18 mm	50 pcs.
50 mm	L-HLZ50	Corrugated board processing machines	12 mm 15 mm	50 pcs.

Steel rails, lower part stabilization

Name	Item no.	Application	Version	PU
25 mm	L-STL25	Paperboard processing machines	4 mm 6 mm	50 pcs.
35 mm	L-STL35	Paperboard processing machines	4 mm 6 mm	50 pcs.
50 mm	L-STL50	Corrugated board processing machines	2 mm 3 mm 4 mm	50 pcs.

Fixing elements for steel rails

Name	Item no.	Application	Version	PU
Mounting angle steel	07481	rails fixation wood and steel		500 pcs.
Flat head screw	13280	mounting steel rails (angle)	M6x12 mm	100 pcs.
Flat head screw	00738	mounting wooden rails claw		100 pcs.
Drive-in nut	04986	assembly lower part with angle	M5x8 mm	1,000 pcs.
Flat head screw	13284	assembly lower part with angle	M5x10 mm	100 pcs.
Claw plastic	14284	assembly with rails	25 mm	100 pcs.

Cross stabilization SPD

Name	Item no.	Application	Version	PU
Stabilization tube	07483	Assembly with wooden rails	2,000 mm	25 pcs.
Clamping block standard	09158	Assembly pipe with female tool		100 pcs.
Clamping block end piece	09157	Assembly of pipe with female tool		100 pcs.
Lens head screw	14163	Assembly of clamping blocks	M5x30 mm	100 pcs.

STRIPPING.



Stripping rules

Rules for stripping waste. For highest functionality.

PU = 500 pcs.

Item no.	Name
09488	100x50x1mm Perfo
09480	25x50x1mm Perfo
09475	25x55x1mm Perfo
09481	30x50x1mm Perfo
09476	30x55x1mm Perfo
09482	35x50x1mm Perfo
09483	40x50x1mm Perfo
09477	40x55x1mm Perfo
09484	45x50x1mm Perfo
09478	45x55x1mm Perfo
09486	50x50x1mm Perfo
09479	50x55x1mm Perfo
09487	60x50x1mm Perfo
09210	25x55x1mm Smooth
09211	30x55x1mm Smooth
09212	35x55x1mm Smooth
09213	40x55x1mm Smooth
09215	50x55x1mm Smooth
09216	60x55x1mm Smooth
09217	100x55x1mm Smooth



Stripping claws

Unique. For dynamic stripping. The waste is held in place with the claw tips. And pressed through the lower tool. The special support technology in the lower tool ensures a controlled stripping of the waste. Available in various sizes. Left and right.

PU = 500 pcs.

Item no.	Name
09502	4mm left
09503	4mm right
09504	6mm left
09507	6mm right
09508	8mm left
09509	8mm right
09501	10mm left
09511	10mm right
09512	12mm left
09513	12mm right
09515	15mm left
09516	15mm right
09520	20mm left
09521	20mm right

further claw types on request



Assembly aid

Simple. But effective. Special assembly aid for the assembly of crown pins or marbastrip claws.

PU = 1,000 pcs.

Item no.	Name
10456	Ø1.8mm
10455	Ø2.2mm
10458	Ø3.0mm
10457	Ø5.0mm
09708	claws



Crown pins

They firmly fix the waste pieces. And are used in places where a claw does not fit. Especially useful for tiny waste pieces. And small side waste. Available in various sizes.

PU = 1,000 pcs.

Item no.	Name
42421	1.8mm
42422	3.0mm
42423	5.0mm



marbafly

A special kind of sheet lifter. For highest productivity. With marbafly the sheet glides through the stripping station. No catching of cartons on the lower tool. No stopping of machines. Simply highest productivity in stripping.

PU = 100 pcs.

Item no.	Name
08968	marbafly c
09232	marbafly s



Quick lock brackets

To safely fix the stripper to the die-cutting machine. The brackets lock the tool into the machine. And enable a stable stripping process. Lightweight, dimensionally stable and cost-efficient.

PU = 50 pcs.

Item no.	Name
08133	corrugated blue
08158	corrugated black
14284	paperboard blue



Spring elements

Special telescope spring elements for Marbach stripping tools masterstrip|plate. In 2 versions.

Item no.	Name
07703	threaded
07706	pin



Distance sleeve

Used as extra screw connection for upper strippers. More stability and safety. Available in different heights.

PU = 100 pcs.

Item no.	Name
50200	20mm
50201	23mm
50202	28mm



Plastic bolt

PU = 1,000 pcs.

Item no.	Name
15463	Ø20x48.50mm
15079	Ø10x48.50mm



Side support bracket

PU = 1,000 pcs.

Item no.	Name
09622	12x22x40mm
09638	12x14x40mm



Foam cubes

For stable stripping; foam cubes as down holders. Self-adhesive. In various sizes. Just peel them off, put in place, done. For maximum productivity when making stripping tools.

PU = 1 box

Item no.	Name
03248	30x40x40mm (4,752 pcs./box)
03247	40x40x40mm (3,600 pcs./box)
03246	75x40x40mm (1,872 pcs./box)



Head screw

For highest production safety. The head screw locks the stripping or blanking upper part in the machine. That way the bending of the upper part is prevented during production. For maximum safety.

PU = 25 pcs.

Item no.	Name
14217	Fixing set; 1-pc.
07439	Fixing set; 4-pc.

STRIPPING.



Side trim brake knife

PU = 100 pcs.

Item no.	Name
04342	100x24x12mm
04347	100x24x15mm
04345	70x24x12mm
04344	100x62x12mm
04341	100x62x15mm
04340	30x62x15mm
07444	70x62x12mm
04343	70x62x15mm
07426	30x24x12mm
07449	30x24x15mm
07443	30x62x12mm



Distance bolts

Always the correct wood distance of the upper stripper. With the distance bolts from Marbach.

PU = 100 pcs.

Item no.	Name
14430	14.5x28x11.5mm
14422	14.5x23x11.5mm
14424	14.0x20x14.0mm



Speed Lift and Speed Lift-S

Sheet lifter for stripping tools. Retrofittable. In 2 sizes. The Speed Lift Precision Drill drills the appropriate cut-outs.

*PU = 500 pcs.

Item no.	Name
13045	Speed Lift
13046	Speed Lift Precision Drill
13091	Speed Lift-S
13092	Speed Lift-S Precision Drill-S



Bridge rule

Filling material as bridge rule for larger waste pieces. in the lower stripper. Prevents collisions of cut sheet during transport.

Item no.	Name
04287	12x1.05mm
04205M	12x1.50mm
04204M	12x2.00mm



Clamp

With Mastercut machines. Connects both guillotines. Ensures a safe transport. And space saving storage.

PU = 100 pcs.

Item no.	Name
19000	Clamp



Precision lower pin

Special precision lower pins for stable stripping processes in packaging production. It is manufactured extremely precisely from high-quality materials and is very accurate in position due to its narrow guide tolerances. Re-adjustment in the die-cutting machine is not necessary. For trouble-free and waste-free stripping processes.

PU = 50 pcs.

Item no.	Name
00278	standard (4mm)
00277	reduced diameter (2mm)



Bottom pin

The standard bottom pin for stripping: 4 mm. And for smallest waste parts: a special bottom pin, turned down to 2 mm. So that even the smallest waste parts can be stripped safely and stably.

PU = 50 pcs.

Item no.	Name
10841	reduced diameter (2mm)
10840	standard (4mm)



Clamping bracket

For a quiet stripping process. The cross stabilization prevents the tools from bowing during the stripping process. Available as set.

PU = 200 pcs.
*PU = 1 pcs.

Item no.	Name
07483*	tube, lower stripper
09158	clamping block, standard
09157	clamping block small, end piece



Transport Lock

For more safety when transporting stripping tools.

PU = 100 pcs.

Item no.	Name
14061	countersunk screw for nut
42333	distance tube 39mm high
42334	distance tube 32mm high
07417	fitting nuts; 15mm high
07412	fitting screws; 21mm high
07418	fitting screws; 43mm high



Easy-Fix and Easy-Fix-S

Transport locks for tools. One-piece, making them fast and safe to handle. Available in the two versions Easy Fix (male and female stripper) and Easy Fix S (guillotine with tool).

PU = 1,000 pcs.

Item no.	Name
07450	Easy-Fix blue*
06900	Easy-Fix-S blue*

*only as long as stock lasts



marbapoint

The precision set-up helper for a highly efficient stripping process. So set-up of the stripper in the cutting machine is easy as pie.

Item no.	Name
09966	marbapoint set
09984	marbapoint
09985	spare battery
15048	recording socket
09971	magnet holder marbapoint

BLANKING.



Jogger tape

Jogger tapes for guiding the blanks during the blanking process. With steel inserts. They ensure safe stacking of the blanks.

Item no.	Dimensions
14157	19 mm; 16.5 m
44030	25.4 mm; 16.5 m
07550	steel insert 12.7x0.10 mm; 5 m



Center block for male blanker

Center block for insertion into the blanking tool. Ensures fast and accurate positioning of the tool in the die-cutting machine. For fast set-up times.

PU = 100 pcs.

Item no.	Name
07427	center block for male blanker

further versions on request



Distance element

Distance element for stripping and blanking tools. Provides best stability due to its extra large contact surface.

PU = 100 pcs.

Item no.	Name
14425	bolt (30 mm)
50203	sleeve (30 mm)

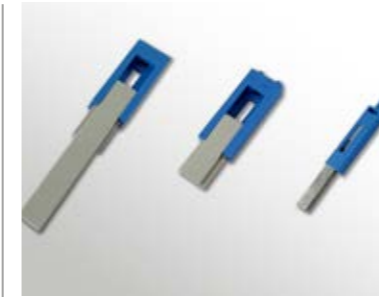

Joggors

For optimum guidance of the separated blanks in the edge area. Lightweight, stable and inexpensive. Available in various lengths. Individually adaptable.

PU = 100 pcs.

Item no.	Name
99072	standard
99073	version long
09927	version small



marbapusher|p

This presser is an allrounder. It can be used for both presser plates and custom-shaped presser bars. And it saves storage space as it doesn't stand out on the back of the tool.

PU = 100 pcs.

Item no.	Name
34134	marbapusher p



marbapusher|s

The Marbach telescopic presser. Lightweight, functional and space-saving. Flush to the back of the tool. Fits even where there is little room.

PU = 100 pcs.

Item no.	Name
34147	marbapusher s

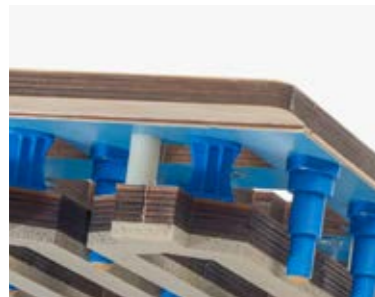

Wood and rubber

Building tools like professionals. With original materials from Marbach. For blanking: 18mm wood and 7mm moose rubber. Well equipped for an efficient blanking process.

Item no.	Dimensions
00934	multiplex 1,500x1,120 mm
03044	moose rubber 1,000x500 mm



marbapusher-set

Pressers designed by Marbach. Lightweight, versatile and economical. Quick and safe assembly in seconds. Set of 25 pieces with fitting keys. Without screws.

Item no.	Name
34159	marbapusher-set



marbapusher

Pusher developed by Marbach for the selective fixation of waste areas. Lightweight, flexible to use and inexpensive. Quickly mounted and easy to handle.

PU = 100 pcs.

Item no.	Name
34158	marbapusher



Pressers

Conventional pressers for male blankers. Usable with a bar. As a spot presser or in a presser plate. Stable, reliable and popular.

Item no.	Name
34148	spot presser
34149	for presser plate
34150	for presser bar

Marbach Group
Karl Marbach GmbH & Co. KG

Karl-Marbach-Straße 1
74080 Heilbronn
Germany
phone +49 7131 918-434
supplies@marbach.com
www.marbach.com

**PACKAGING.
PERFORMANCE.
YOU.**

Marbach reserves the right to make changes without prior notice.

(c) marbach 2021

Stand 01.10.2021