



MARBACH

**PACKAGING.
PERFORMANCE.
YOU.**





EDITORIAL.

The world is evolving. The packaging industry as well. As are your requirements. And those of your customers. Individualization is the slogan of the future. A product does not have only one kind of packaging. It has many. One Easter edition. One summer edition. One winter edition. And on top of that various special sizes. And all this for one and the same product.

We are all part of this evolution. You as our client. We as a manufacturer of cutting dies. Of thermoforming tools. Of machines. And materials. As the Marbach Group. In these changing times we at Marbach concentrate on one clear goal: the best performance. For you. Your demands. And not only in the high-end segment. The best performance in every price range.

Our experienced team does everything to enhance your performance. With every process. Every thought. And every breath. For you.

You can sense it when our experts advise, support and attend to you with experience second to none. So you are in safe hands. And always one decisive step ahead. With the best performance.

Packaging. Performance. You.
Come with us – into a successful future.

Peter Marbach
Owner & Managing Director Marbach Group



| | |
|--|----|
| PACKAGING. | 8 |
| The world of packaging | |
| A history of success | |
| PERFORMANCE. | 14 |
| By Marbach | |
| In all areas | |
| YOU. | 20 |
| In the best hands | |
| Logistics | |
| CSR – Taking care of the future | |
| PRODUCTS. | 26 |
| Thermoforming tools | 28 |
| Thermoform in-mould-labelling | 36 |
| MM TEC vs. SR TEC | 38 |
| Match-metal (MM TEC) | 40 |
| Technology MM TEC | 42 |
| Steel-rule (SR TEC) | 48 |
| Technology SR TEC | 52 |
| Accessories MM TEC & SR TEC | 54 |
| Rotary cut, crease and embossing tools | 56 |
| Cutting dies | 62 |

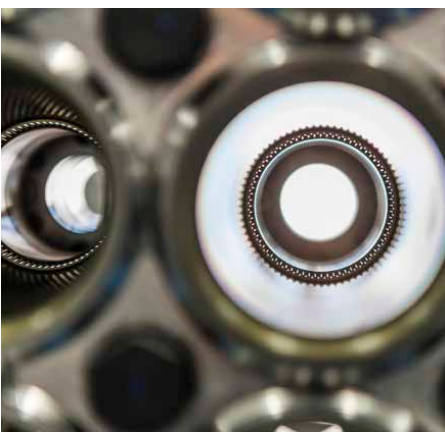
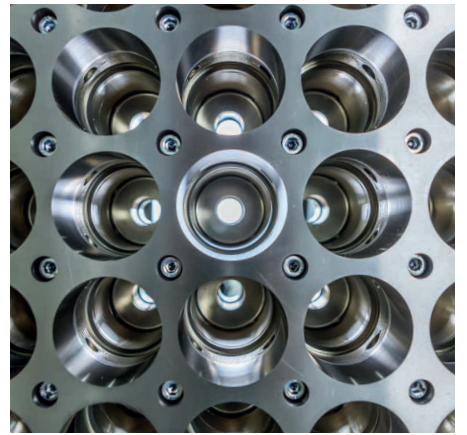
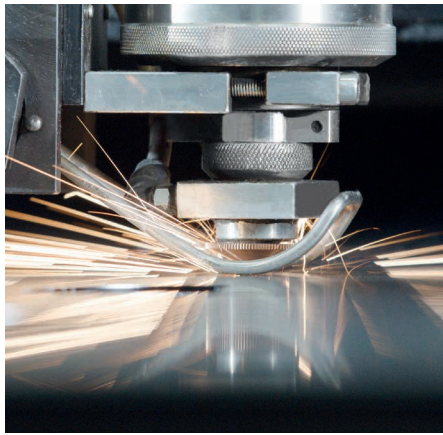
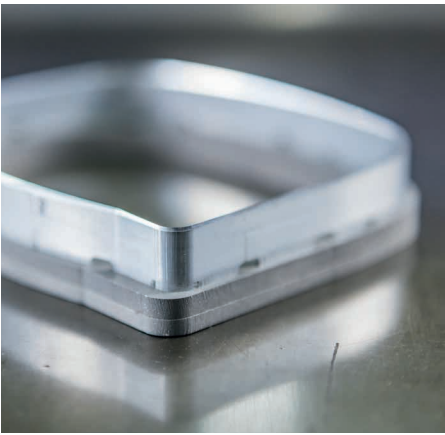

PACKAGING. WITH PASSION.

Be inspired. By stories about the packaging industry. About Marbach. And about what Marbach can make possible for you. Be excited. By the best performance. Of products made for you. Individually. With passion. With experience. Each one custom made. Be delighted. About everything we can achieve for you. With cutting dies. With rotary tools. With thermoforming tools. Machines. And materials.

The best performance in every price range. The right solution to every challenge. This is Marbach.

Packaging – the benchmark of the entire industry

With us, you count on the company that has defined tool manufacturing of the packaging industry. World-wide. With decades of innovation and quality leadership.

Performance – the maximum output

With every thought. With every move. And with every breath we work on optimizing your performance. Without compromise. This is why at Marbach you will find the maximum performance. In every price range.

You – with us, it's all about you

You are our focus. Our declared goal: to make your life easier. That's what our experts work for. Day by day. With unique knowledge of the industry.

Learn more online

www.marbach.com



PA
C
KA
GI
NG.

PACKAGING.

One industry. One challenge.
The right packaging for every product.

The functions of packaging are diverse.
Like ourselves.

Flexible and customized.
That describes not just the packaging industry.
That is Marbach.

Incredible diversity of packaging.

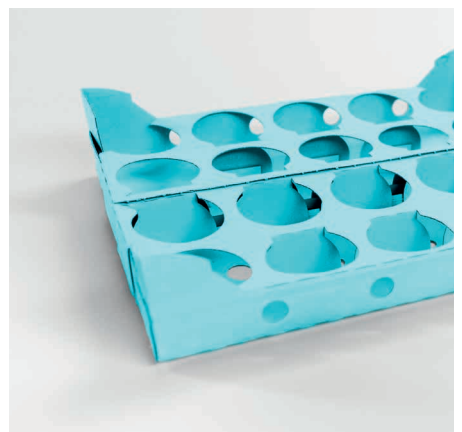
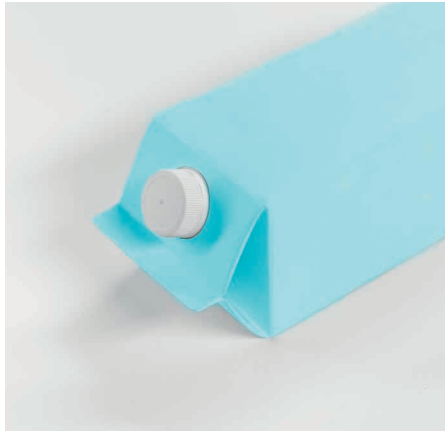

THE WORLD OF PACKAGING. THE WORLD OF MARBACH.

The world of packaging – that is our domain. We know what counts. How to find solutions. To realize every idea you have. With paperboard. With corrugated board. And with plastic.

The portfolio: Uniquely diverse

Yoghurt cups. All made with a Marbach tool. The single cups: each separated precisely with a Marbach steel-rule tool. The fitting in-mould-labels: of course made with a Marbach label die. The cups will sit on the grocery store shelf. Packaged as a container in a wrap-around sleeve from paperboard. Or individually in a corrugated crate. So nothing moves. For safe transportation. Everything optimally cut. And formed. Of course with Marbach.

We have been in this industry since 1923. We are distinguished by the incredible amount of experience and pleasure we have in our work. Our pioneering spirit. And providing a variety second to none. We employ synergies. Whenever possible – for your success. We are at home in this industry. And you can tell. Because we are never satisfied until you are. Without compromise. We listen to you. And find the right solution. For short runs. And for long runs. For every requirement.

We live in the world of packaging. And work passionately. For you. For your optimal performance.

FROM A 3-PERSON BUSINESS. TO A WORLD LEADER.

Like a gripping novel. That is what the history of the Marbach Group is like. 1923. The economy is bad. Despite this, Karl Marbach Senior dares to start a business. The main product at the beginning: cutting knives for the shoe industry. Then an acquaintance inquires whether Marbach could also supply tools for die cutting of letters. Not yet. But from then on Karl Marbach immerses himself in steel-rule technology. And he is successful. The new customer base: the paper processing and advertising material industry.

World War II. The company building is partially destroyed. Marbach is starting over again. Exhibiting extreme endurance, the firm is rebuilt. Karl Marbach Junior joins the company. Marbach continues to grow steadily. In 1960, Marbach adds to its portfolio of products: the first thermoforming tool. A new field of business emerges: Marbach tool manufacturing. A revolutionary decision follows as Karl Marbach hears about »cutting with light« for the first time in 1968. The idea grows. In 1972: the first CO₂ laser unit for cutting die production in Europe is installed in Heilbronn. Laser technology becomes a major part of the Marbach Group's success.

A new technology. A revolution in die making technology. Marbach utilizes this to win new clients. Also beyond Germany's borders. This new quality is unique to the market. 1977 the first big fair as an exhibitor. drupa in Düsseldorf. Outstandingly successful. More and more international clients order cutting dies »made by Marbach«.



Production in the mid 1920s.



Karl Marbach Junior.



Company Building in the 1960s.



Production in Heilbronn today.



Peter Marbach.

In the year 1984 Marbach takes a significant step. The company expands. The first branch abroad is established. In the coming years its worldwide presence grows. Step by step. Peter Marbach joins the company in 1988 as the third generation. And brings a fresh breeze to the strategic orientation. Marbach invests in its own die-cutting machine in the early 1990s. And analyzes the die-cutting process thoroughly. From now on, not only samples for customers are diecut. But the entire industry is trained by Marbach. Even more than that: it results in numerous innovations. Many of which are industry standards today. Marbach also invests in a sampling machine for the thermoforming branch. For the safety of the customers. For optimal processes. And for the best performance. In 1994, the first cutting segments for rotary tools are produced. Shortly after, the business unit rotary tools for tobacco packaging is developed. Then an unusual strategic decision in the late 1990s: an interesting conclusion. The sale of Marbach machines. Not only to Marbach Group companies. But to the general market as well. The result is the Marbach Automation & Service branch. Marbach starts to sell materials simultaneously. Under the name of Marbach Trade & Logistics, customers worldwide are supplied with die-making materials.

The following decades are characterized by worldwide growth. In Eastern Europe. In the United States of America. In Southeast Asia. And by the increasing collaboration with partners around the globe. Marbach expands its portfolio with embossing dies in 2000. This makes Marbach one of the few companies that can provide die-cutting tools and embossing dies from one source.

In 2008 the new headquarters building is completed in Heilbronn. New factories at our subsidiaries around the world follow. Optimizing processes. And minimizing energy consumption.

Content employees. Excited customers. A unique success story. Continuously growing. At over twenty locations. With numerous partnerships. Around the world. The Marbach Group. With over 1,300 employees. More than 10% of which are apprentices and trainees. All of them stand for: best performance. Yesterday. Today. And in the future.



PER
FOR
MA
NCE.
CE.

PERFORMANCE.

Unique performance.
That is our claim. Our focus.

For your safety. So you can relax. Lean back.
And breathe. With Marbach.

Because we have the right solution for you.
The best performance – in every price range.

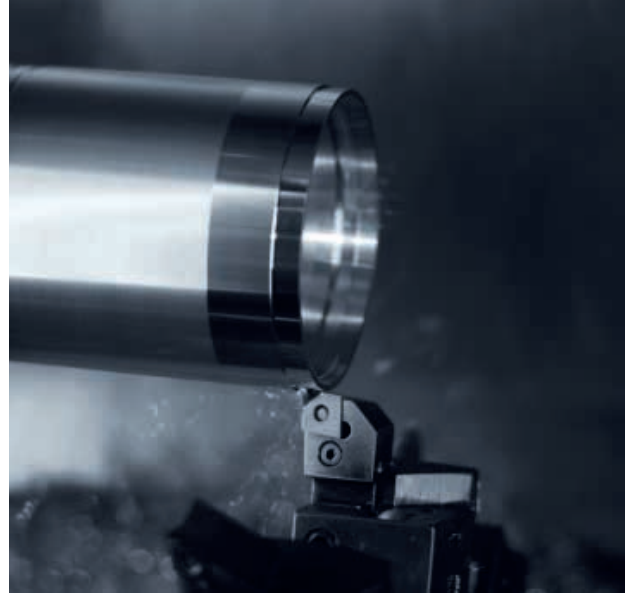

MARBACH. FOR YOUR PERFORMANCE.

We ensure your performance. With the advanced technology of a world market leader. With inventions that become industry standards. Because we develop them from your needs. For you.

We consistently take this path. Without compromise. For decades. For our joint success.

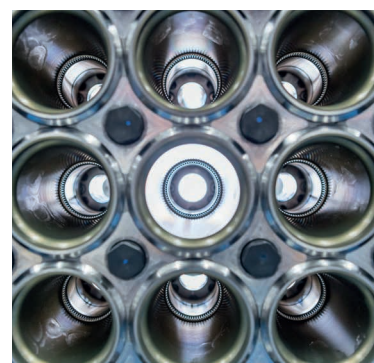



PURE PERFORMANCE. IN ALL AREAS.

You seek performance. While producing your packaging. From paperboard. From corrugated board. From plastic. Performance at the point of sale. While setting up. While filling. While sealing the packaging. While printing. While cutting. While gluing. While manufacturing cutting dies. While laser cutting. While milling and knifing of tools. While thermoforming various plastics. No matter what level of the supply chain you are at. Performance is what counts for you. And us? We have been performing. For almost 100 years.

You have a new die cutting machine and want to produce at maximum speed? 12,000 sheets per hour? No problem with Marbach tools. 1,000 cigarette boxes in one minute. Form. Glue. And fill. It works. No exceptions. If the blanks are cut with Marbach tools.

You need small quantities? We have the fitting tools for that as well. Inexpensive. Simple. No frills. But still the best.

We understand the nature of paperboard. And all its facets. Even when the world is turning. Rotary dies at 300 m/min on gravure presses. We make it possible. For more output. For your clients. For your success.

Producing cutting dies is an art. We know that. That is why we make it easier for you. With machines made by Marbach. Lasers. Milling machines. Water jet machines. Hand tools. All are tested. By us. In everyday production. For best performance.

When investing in a machine you lay the foundations. We deliver the perfectly suitable thermoforming tool. Easy to operate. And to set up. Exceptionally light. Outstanding speed. Pure performance. Beat by beat. Cup by cup. For a long tool life. 3,000 cups per minute. For weeks. For years. Every day.

Ultimately we all want the same thing: to offer our clients the service they expect. And then over-deliver. With something exciting. For packaging that is more than presentable. Made of paperboard. Of corrugated board. Of plastic.



YOU.

YOU.

Breathe for a moment. Relax.
You are with Marbach.

That means: you have made the right choice.
For yourself. For your client. For your budget.
For the best performance.

But most of all for outstanding advice.
And for service that satisfies your needs.



IN THE BEST HANDS. PROFESSIONAL CONSULTING AND SERVICES.

We are at your side. From initial contact. Through ordering process. To delivery. And beyond. After your purchase we are there for you. Our consultants and field technicians are there to support you every step of the way.

Experience. Passion. And joy in what we do. That is what distinguishes our employees. It is this combination you feel when first getting in contact with us. It excites you. Because our service does not end with your order. It continues. Until you hold the product in your hands. And beyond. Until you are delighted.

Experienced Marbach consultants advise you from the start. What are your requirements? How can the package layout be implemented in the best way? Which tool package makes the most sense? Which technique do we recommend?

In this way you will have the peace of mind ordering the tool that best fits your needs. For results that not only convince your customers. But delight them.

And we don't stop there. We are there for you after you have placed the order. You will be supported by our exclusive Marbach network. Throughout the entire ordering process and beyond. Our skilled service technicians will assist you. On site. Worldwide. Because it is important to them that you are in expert hands. Prompt and proficient.

LOGISTICS. PERFECTLY TRANSPORTED.

When it comes to logistics we don't believe in chance. You always get what you expect: the ordered product at the right time. In the best quality. Worldwide. Supplied by us.

That is why in our warehouses we have all important materials in stock. At all times. Almost 6,000 items. In over 4,000 m² of storage area. Our stock is constantly monitored. Orders are placed automatically. For consistent availability. At all times.

So how does the finished product get to you? It is carefully packaged by our shipping department. The delivery: via Marbach transport. Via shipping agency. Via air freight. According to your schedule. Even over night. And we are also a certified known consignor. So you can benefit from fast customs clearance. In order to send materials overseas we rely on container shipments. We load the containers here on site. Your advantage: various materials. In one container. Saves you freight costs. And time.

Perfectly packaged. And shipped quickly. That is how we do logistics at Marbach.



The Mabox. A packaging system for your forming components.

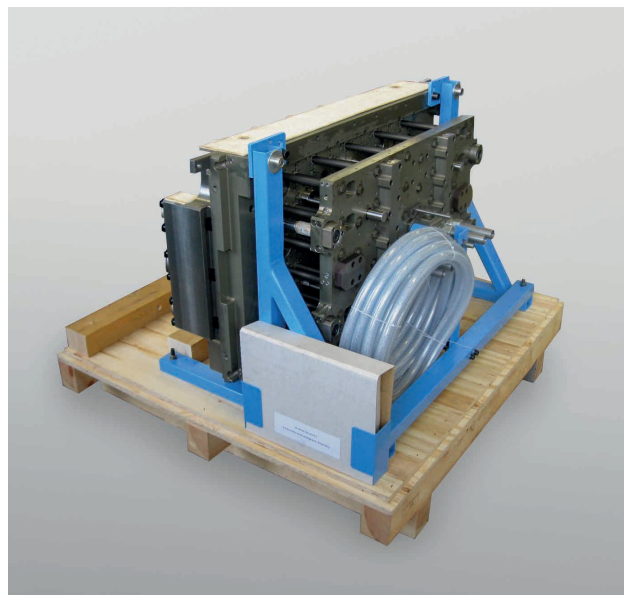

The safe thermoforming tool storage and transport frame Sherpa.



TAKING CARE OF THE FUTURE. CORPORATE SOCIAL RESPONSIBILITY.

As a family owned business we take responsibility for the coming generations. Sustainability has shaped our corporate philosophy. For many years.

We contribute actively to the protection of our environment. With products like the »greenplate«. Or the use of bio plastics. And further programmes such as solar power. With photovoltaics.

Today our activities are documented in a CSR report. Not just the environmentally-friendly activities. Also the social ones. And economic ones. CSR is a vital part of our corporate strategy. With the CSR report providing the guidelines.

With specific sustainability activities we remain at the forefront. Reorientating ourselves time and again. Reviewing our values. Adjusting them. And improving. For your benefit. And for the benefit of generations to come.

Acting to extend and further environmental sustainability is a core value for the Marbach Group. And the very personal concern of Peter Marbach.



TOOLS. FOR THE BEST PERFORMANCE.

Marbach manufactures them. The best thermoforming tools. For yoghurt cups. For food trays. For lids. We are pioneers. Involved from the very beginning. A world-class toolmaker. We maintain this great achievement to the present day. Justified. And proud. Remaining at the top, over many years, requires many things. A strategy. Passion. Effort. Leadership. Role models. And a strong team. But most of all it requires one thing: the drive to be even better tomorrow. This redefines the new. New tools. And innovative technologies. With one goal only: fulfilling your requirements to perfection. For your continued success.

THERMOFORMING TOOLS. THE BEST PERFORMANCE. IN EVERY RANGE.

With Marbach tools you are on the safe side. Because we have the expertise. The experience. The technologies. And the tools that will place you at the forefront. We will do everything. For a rewarding partnership. For your satisfaction. For your enthusiasm. With sophisticated technology. With common sense. With extensive experience. And with the opportunity to make in-house tool start-ups. For your competitive advantage. Made by Marbach.





We are state-of-the-art. In technology. We know the trends. We evaluate. We innovate for your benefit. 3D-printing. Laser-scan. Or material analysis. We have the latest technologies. And we work closely with reliable partners. Discover new ideas. Analyze challenges. Solve problems. Our innovative potential is limitless. For your success.

Small tooling formats

FAST AND FLEXIBLE.

fast delivery times

reliable quality

standardized technology

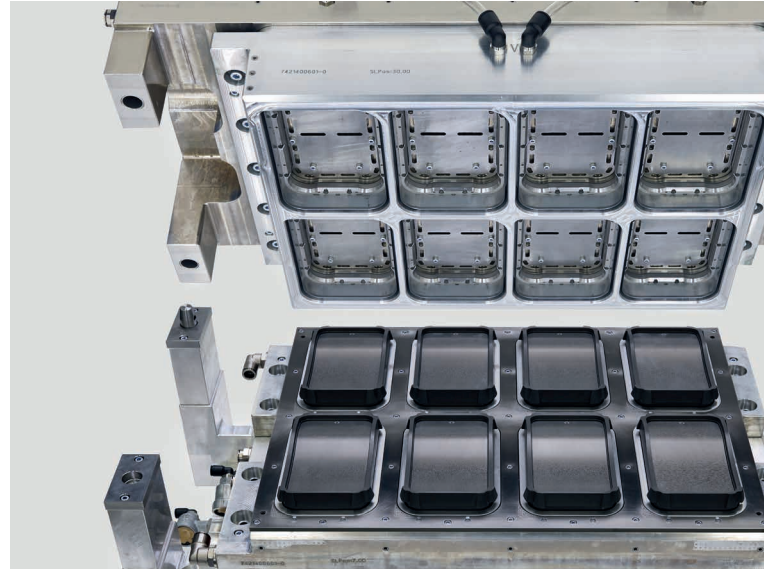

Medium-sized & large tooling formats

EFFICIENT AND LONG LIFE.

highest numbers of strokes

highest life span

efficient



XXL tooling formats

MANY CAVITIES AND RELIABLE.

highest number of cavities

stable design

maximum productivity

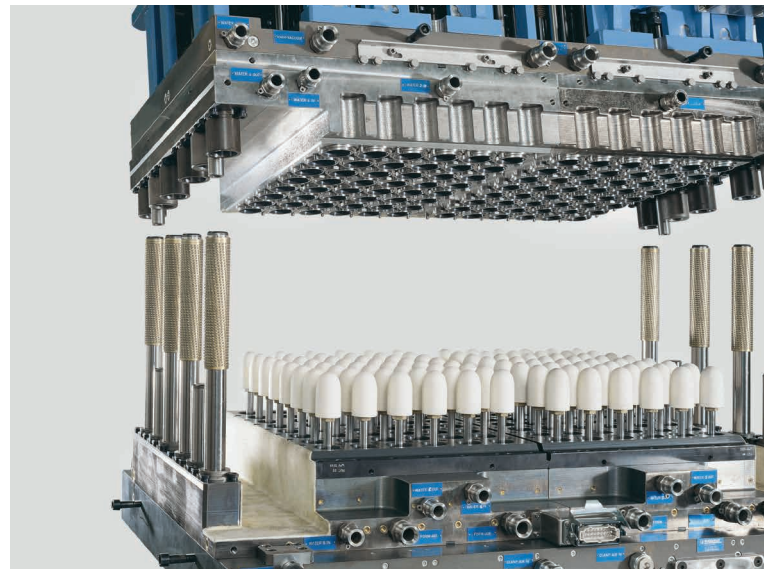



Smaller quantities. And more individualized packaging. This requires more exact fitting, tooling and machine concepts. To reduce make-ready time. And also realize short terms economically. Our tooling standards balance the very best quality. With low costs. And short delivery times.



This tooling class is our primary discipline. Most standards are developed by us. And we continually refine them. For you. For your competitive advantage. Your performance. And for your customers. Tools you can rely on.



Extra large tools with trim-in-place technology. For more output. And best quality. Our largest tools measure 2,000 x 1,200 mm. With up to 140 cavities. That's a record in trim-in-place technology. Double to fourfold numbers of cavities require fully developed technologies. And highest precision. For the best performance. In every price range.

Forming tools

THE SHAPING ONES.

maximum cooling

from small to extra large

for cups and lids



Trim tools

THE PRECISE ONES.

fitting cutting gaps

precise guiding

from small to extra large



Stacker

THE ALIGNING ONES.

reliable

light

thoughtful





Separated forming and trimming is a major trend. Also for complex shapes. For small quantities, tools have to be simple. Other tools should do more. Much more. They have to ensure high performance. For example for cups. Produced in a post-trim process. By Marbach. For best performance. In every price range.



Sometimes you will need to simplify things. Separated forming and trimming allows that. In match-metal or steel-rule technology. Optionally with additional punching unit. With our tools you can also manage the trim off-set. If needed, we equip the tools with free-flow steel-rules. Or adjustable punch in match-metal trim tools. We produce small and fast trim tools. Also for the exceptionally large ones. With highest precision. For long tool life span. And a clean cut. Always tailored to your needs.



You need to organize everything safely, while producing. Reliable stacking of products is essential. For high productivity. And consistent quality. We produce format parts for all stackers. For simple chute stacker. For rotary stacking. But also for automatic stacking systems. Suited to your end-products. Fitted to your machines. For the productivity you need.

THERMOFORM-TESTING TOOLS. THE HIGHEST LEVEL.

Your processes. We know and understand them. Our processing experts help you on-site. With a lot of experience. Because we have our own thermoforming machines. A match-metal tilting machine. And a steel-rule trim-in-place. For the start-up and sampling of steel-rule tools. In order to ensure that your tools run smoothly. Right from the start.



Test your tools. For your success.



DEVELOPING PACKAGING. EFFICIENT. AND CREATIVE.

Time-to-market is a key success factor. You need a team of professionals to ensure rapid processes. And also effective communication. Trust. The right tools. And the drive to succeed.

We support you in developing prototypes. We find solutions. New shapes. New packaging. We identify the perfect shrinkage value and process settings for your tool. And your material. Whether prototype or 0-series. With our own machines we can produce with flexibility and speed. For you. And your customers.

We coordinate everything expertly when developing new packaging for thermoforming in-mould-technologies. Tools. Labels. Packaging. Everything from a single source. And if needed overnight.

THERMOFORMING IN-MOULD-LABELLING. EYE-CATCHER AT THE POINT OF SALE.

Some packaging needs to be more attractive than others. T-IML ensures this. Bright colors. And clean characters. For a modern product design. T-IML allows efficient production of packaging in a single step. With all the benefits of thermoforming technology. Minimal product weight. Barrier sheets. High throughput. Our technology ensures the perfect positioning of the label. Without loss of forming area. With the maximum number of cavities. With MT|easy speed also with the highest numbers of strokes.

We deliver what is required from a single source when we develop products. We are also able to customize label formats. Immediately. And produce O-series. Quickly and efficiently in-house.

We are pioneers in T-IML technology. With much specific knowledge and practical know-how. For label layout. For cutting. And the tool building. With expert partners. With thermoforming machines from Kiefel. And automation systems from Ilseemann. For even more experience. Professional equipment. For best performance.

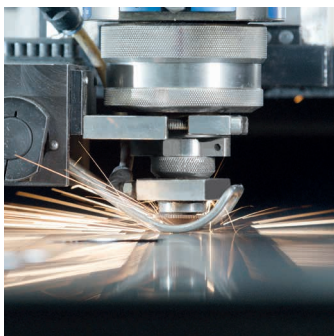



PERFECTLY FORMED. AND CUT. UNIQUE PERFORMANCE.

Two technologies. Leading in thermoforming technology. With outstanding results. Thermoforming in perfection. With match-metal (MM). Or steel-rule (SR) technology. Forming. And cutting. Either in one step. Or two. Together, these technologies can fulfil most requirements regarding thermoformed packaging. So without doubt we will have the right solution for every application.

MM|TEC

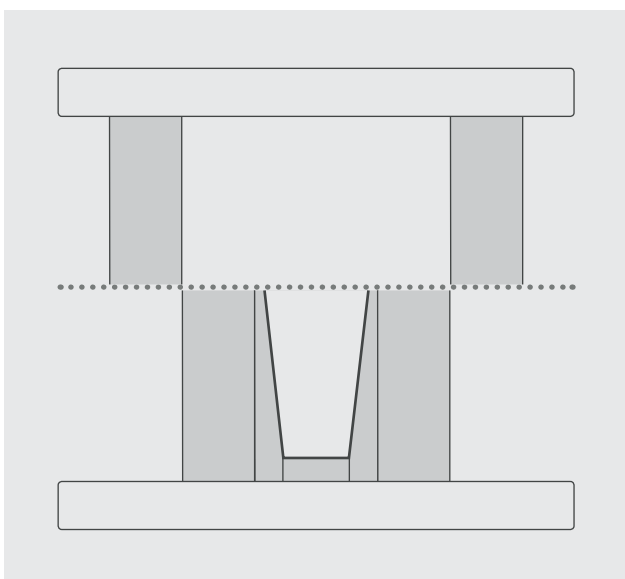

Match-metal technology.

SR|TEC

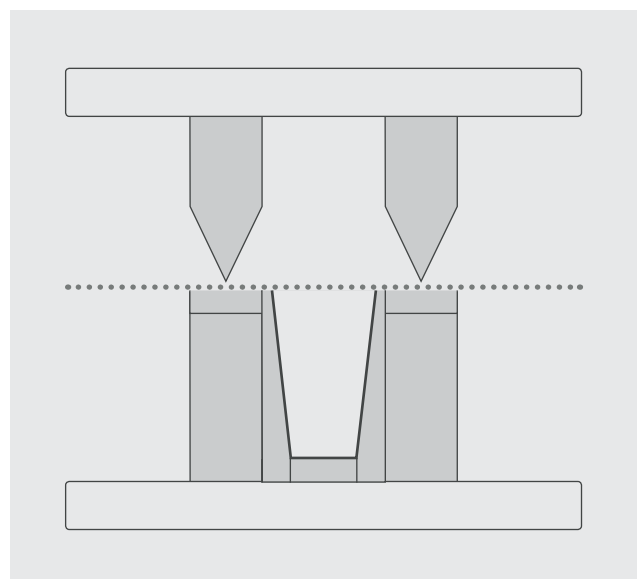

Steel-rule technology.

MT|easy speed

MATCH-METAL TECHNOLOGY. PERFECTLY FORMED.

MT|easy speed. For a unique competitive advantage. Because this Marbach technology is optimally matched to the newest generations of thermoforming machines. With MT|easy you can rely on proven performance enhancements. More speed. Longer tool life. And better product quality.

More speed. Due to a solid aluminum structure. And tool weights reduced by 33%. This significantly relieves the drive of your production machines. The temperature transfer speed of aluminum is seven times faster than steel. This considerably reduces the cooling time of your product's critical areas. And causes an increase in cycles. For more output.

Longer tool life. With MT|easy speed. This provides you with high-end equipment. Not produced with conventional tool steel. But with special powder metallurgical (PM) steel. For cutting parts with outstandingly high durability. For extremely fast adaptation to temperature fluctuations. For minimal wear of cutting edges. Even if abrasive material combinations are used. Your advantage: long service life. With fewer revisions.

Highest performance. MT|easy speed allows the user a broader operating window. This simplifies handling and improves product quality. And reduces start-up times. For best performance.

Match-metal at its finest. MT|easy speed. The animation. www.marbach.com/MT

higher cycle numbers

long tool life

reduced tool weight

MT|easy speed. PM steel meets aluminium.
For your performance.



pre-stretch plug-system

THE FITTING ONE.

latest materials

optimized geometries

matched to the process



Mafox|P

THE FAST ONE.

short changing times

for round and square shapes

advantages through standardization



4M|Motion

THE FLEXIBLE ONE.

reduced material input

maximum wall thickness in the corners

doubled top-load values

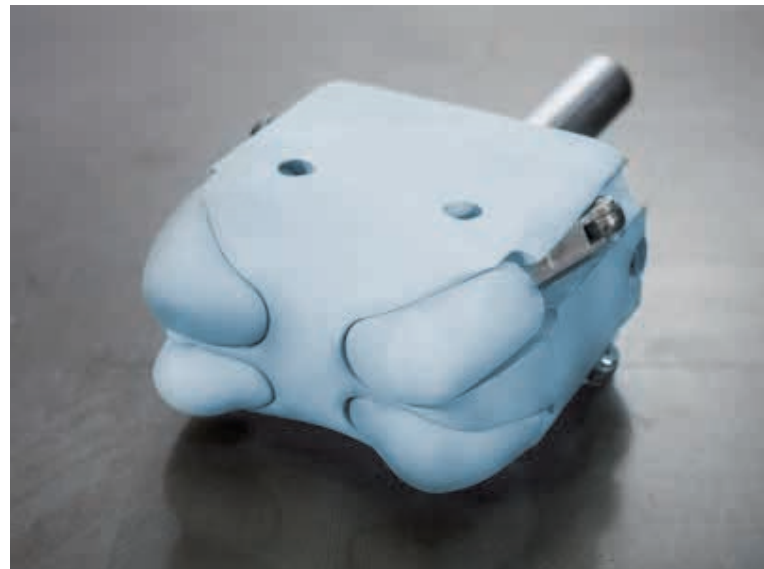



Pre-stretch plugs have a significant influence on the thermoforming process. No matter which materials you need to process. We have the right plugs for your application. For perfect results. Our up-to-date simulation-software-tools provide greater certainty for you. As well as 50 years of experience in the development of plugs. Perfect performance. For your thermoforming process.



To maximize efficiency while operating the thermoforming process, short changing times are crucial. Our Mafox technologies speed up your operating process: Mafox|P ensures the speedy changing of plugs. In less than one second. And also the safe and quick installation of the new plug. In less than half a second. Also available for systems with two bars. With Mafox|PS.

Fast plug changes. With Mafox|P. The animation. www.marbach.com/Mafox-P



Marbach combines the »best of two worlds« through the patented 4M technology. The pointy plug supports a thin article bottom. The wide plug creates stability in the corners that are difficult to form. In the past, it was necessary to choose between these two options. Either one or the other. But not with the 4M technology. It combines the advantages of both plug shapes. The functionality is simple. The plug alters its shape during each movement. This is how optimized material distribution is achieved.

independent clamp ring pressure

THE CONSTANT ONE.

ideal sealing flange control

high process precision

reduced need of cutting force



Precisely control the pressure of the clamp ring in the thermoforming process. And maintain this pressure despite the pending forming pressure. With Marbach's technology of independent clamp ring pressure. This technology can be used in combination with the multi-pressure control of modern thermoforming machines. The clamp ring is completely released for cutting. The full utilization of the machine potential is thereby enabled. For the best performance.

The animation. www.marbach.com/icrp

highest cycle numbers

seal bead embossing

short changing times



Mafox|F

THE SIMPLE ONE.

Clamp rings have an important influence on the thermoforming process. Especially on the shaping of the sealing flange. The more precise the adaptation of the clamp ring shape to the desired article shape. The better the final product is. In particular for articles with U-rims. Clamp rings can be perfectly fitted to the finished product. Also varying foil thickness in a tool is possible with Mafox|F. Without time-consuming clamp ring changes.

Marbach air technology

THE SUCCESSFUL ONE.

for highest cycle numbers

low-forming air consumption

short filling times

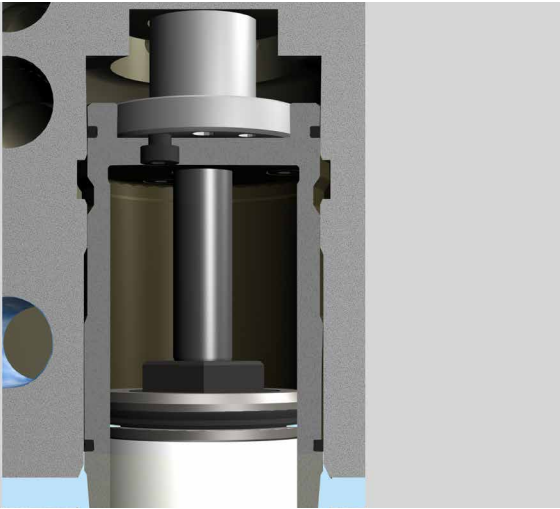

Our proven Marbach air technology (MAT). It accounts for almost 80% of forming air reduction. Your advantages: The filling time is halved. Highest forming quality. Highest cycle numbers. And reduced air consumption.

Marbach air technology. The animation. www.marbach.com/air

highest cycle numbers

efficient cooling

fast reaction time

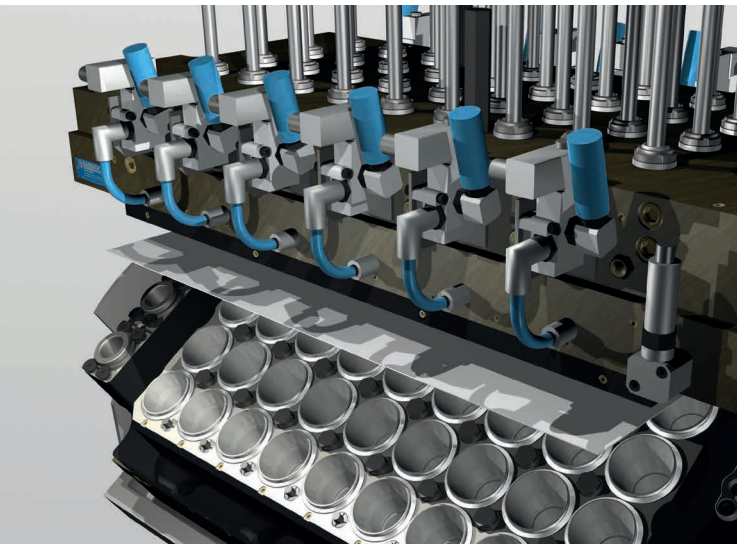

Marbach air valve

THE RESOUNDING ONES.

Marbach air valve (MAV). The extra for a fast vent. With valves that are integrated into the tool. For shortest ways. Fast reaction time. Highest cycle numbers. Optimized cooling times. And maximum output.

Sandwich technology

THE COOL ONE.

highest cycle numbers

maximum sheet utilization

maintenance free

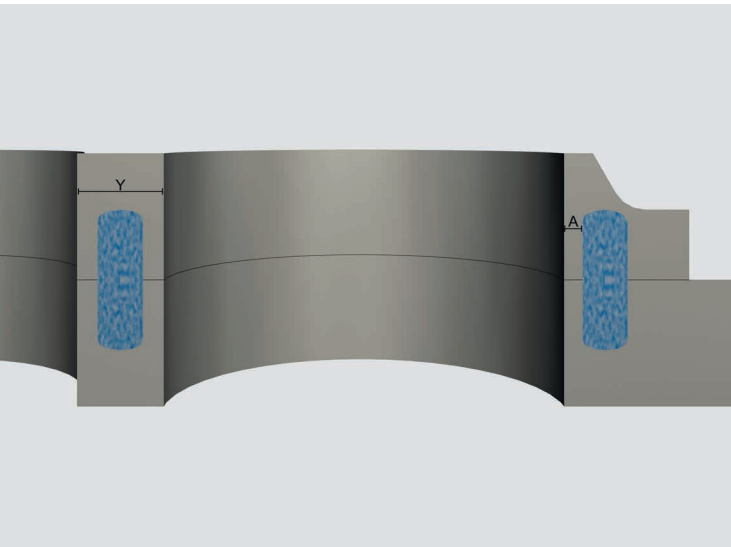

3-times tool life

maximum cooling

highest stability



Marbach's sandwich technology. The unique Marbach standard. For highly efficient die plates. And best cooling. No other concept combines the ideal, contour-true cooling (A) with minimal space requirement (Y) as effectively as this Marbach technology. Proven in over a thousand tools. In use worldwide.

PM steel cutting part

THE LONG LIFE ONE.

Powder metallurgical steel (PM). A material with outstanding advantages. Multiple tool life. Highest performance. Dimensional stability. Dynamics. And hardness. The MT|easy concept allows economical utilization of prefabricated elements. For faster delivery times. Maximum speed in combination with solid body aluminium tools. And multiple tool life spans.

Mafox|2

THE FAST ONE.

short change-over times

for round and rectangular shapes

integrated vacuum

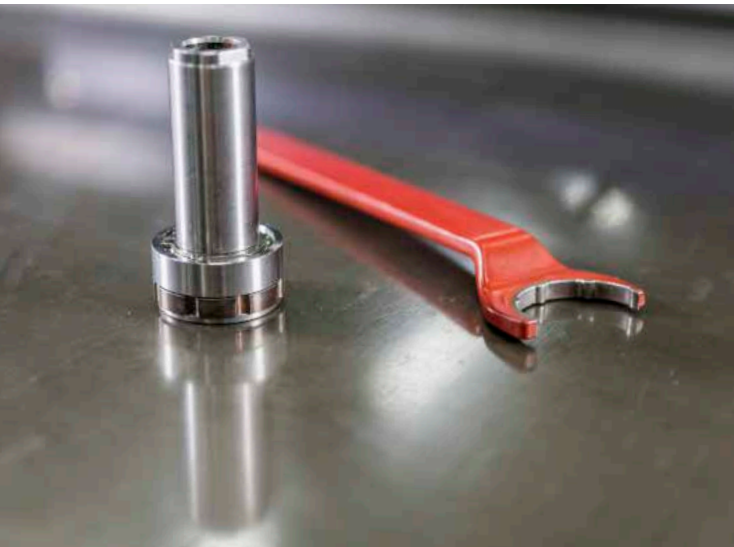

Mafox|2. A proven system. Used in thousands of forming bottom units. It allows a bottom change within seconds. It is robust. Guaranteeing positional accuracy. Also with non-round shapes. Including cooling water supply. Optionally for forming bottom vacuum. Available in three different sizes. Perfectly tailored to your needs.

Mafox|2. The animation. www.marbach.com/Mafox-2

outstanding tool life

precise cutting

reduced maintenance



Six-pack

THE GUIDING ONE.

The six guide pillar system. Invented by Marbach. Today an industry standard. Without it, high-performance thermoforming is unthinkable. The pre-centering allows tightest fit. For best-cutting results. For a longer tool life.

SR TOOLS.

STEEL-RULE TECHNOLOGY. THE REVOLUTION.

Close to 100 years of experience in producing cutting dies. With more than 50 years of manufacturing thermoforming tools. This is Marbach. With unique, concentrated expert knowledge. All transmitted into Marbach's SR technology. And it pays off today. As your competitive advantage.

SR tools provide highest precision. Resulting in maximum success. The two essential advantages of Marbach's SR technology: the Flexi-Tab-System. And the Marbach Silverline 23.8. With a free-flow holding system. Providing innovative competitive advantages. For convincing steel-rule products.

A whole new level of product quality. With the Flexi-Tab-System. The nick-tabs make the nicks on the product disappear. And they make your steel-rule product flawless. Individually adapted. To your needs.

Experience that is unequalled. Marbach has perfected cutting dies. Since 1923. Year after year. This is why steel-rules by Marbach are the undisputed number one in the world today. You too can profit from this unrivalled cutting quality. With the Marbach Silverline 23.8. A Marbach standard. In every SR tool.

SR tools. The animation. www.marbach.com/SR-tools

no make-ready time needed

no visible nicks

optimal cutting quality

Marbach SR|TEC.
For highest precision.

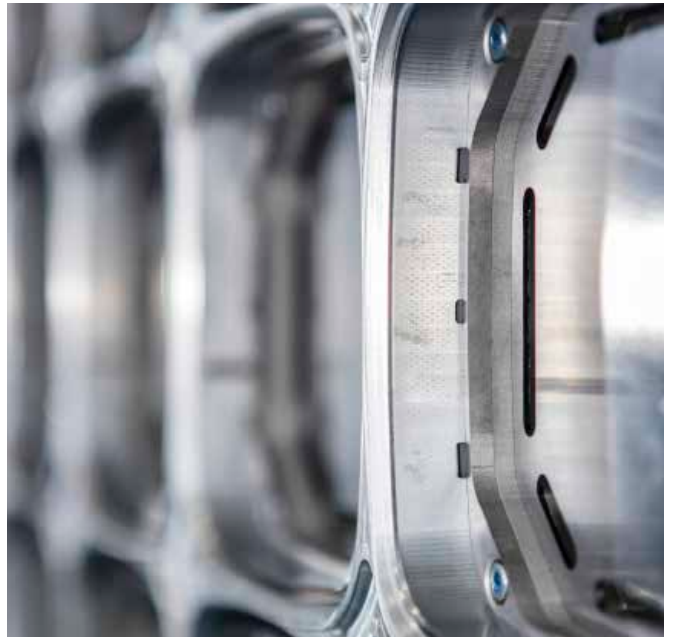



TOOLING VERSIONS SR TECHNOLOGY.

THE NEW MARBACH MODULAR SYSTEM.



Flexible and simple. Build yourself the perfect tooling package. Piece by piece. Individually. For the best performance.

smart

For all those unwilling to miss out on Marbach quality even with short runs. Low costs. Quick delivery. The tool is ready to race. With the Marbach Silverline 23.8. In a free-flow two-part-holder. A function test on our steel-rule machine is included.



performance

For everyone who has made production performance their top priority. Maximum output. Minimum set-up time. With all the benefits of the smart version. And the Flexi-Tab-System. For invisible nicks. Mafox|3 ensures fast format change. In mere seconds.



performance|+

For everyone willing to invest in the future. With the most durable premium tools. For the most challenging jobs. For fastest format changes.

The modular system for steel-rule tools. For best performance. In every price range.

Silverline 23.8

THE SHARP ONE.

unbeaten performance

coated

reduced need of cutting force



Flexi-Tab-System

THE INVISIBLE ONE.

for best end-product quality

highly flexible

always reproducible



Mafox|3

THE FAST ONE.

short changing times

for round and rectangular shapes

integrated centering unit

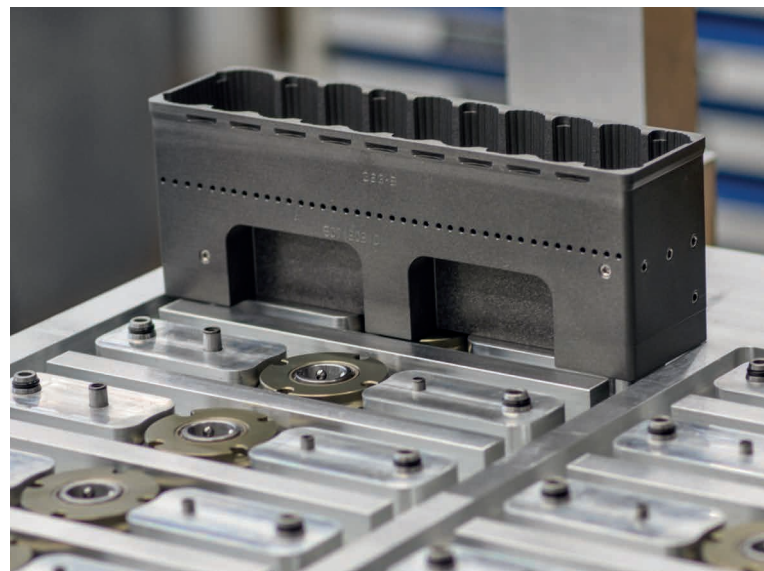



The Marbach Silverline 23.8. Heart of Marbach's SR technology. In combination with the Marbach free-flow holding system. This coated cutting line is extremely sharp. And still very pressure-resistant. Its thin shape ensures highest contour accuracy. Especially three features make it strong. Its coating. Its sharpness. And its flexibility. So no make-ready time is needed. And ensures complete success. And best performance.



The Flexi-Tab-System. Invented by Marbach. It creates a new range of application for SR technology. Because it replaces the conventional nicks in the steel-rule line. Variable nick tabs eliminate the major disadvantage of the conventional steel-rule line. This allows a new product quality. Attractive and sales-boosting packaging. Without annoying nicks.

The Flexi-Tab-System. The animation. www.marbach.com/FTSystem



The Mafox|3 system permits a bottom change within seconds. It is extremely robust. And it can be controlled through an air-pressure impulse. The bottom is released and lifted with a vacuum suction plate. One or several Mafox|3 units can be used. Depending on the bottom size. An integrated centering unit provides a positionally accurate fit of the forming insert. Also for large shapes.

Fast bottom change. With Mafox|3. The animation. www.marbach.com/Mafox-3



marbaspy

Quickly installed. The measuring device marbaspy. To measure the parallelism of tool and machine. Safely and quickly. For a solid and exact positioning. The basis for short start-up times. And a long tool life span.



Dr. Cool

Good water quality is one of the major requirements needed for functional tools in the long run. With Dr. Cool you can carry out an on-site water analysis. Quick and easy. You can also send us your water samples. If you wish to have a more detailed examination. To ensure that your tools run smoothly.



Measuring kit

All tidied up. With the Marbach tool kit for measuring an article's dimensions. All you need for measuring is included. Ruler. Illuminated magnifying glass. Thickness gauge. Scissors. Scalpel. Among other things.



Toolmaster kit

Everything at hand. In the toolmaster kit you can find all necessary equipment for the maintenance of your thermoforming tools. This includes special keys. A torque wrench. Food compatible grease. Mafox¹ ratchet-kit. Special glue. Tool felt.



Assembly table Liftmaster

The solution for an optimal assembly of tools. Fast. And safe. For the tool. And the employees. Limitlessly adjustable. And turnable.

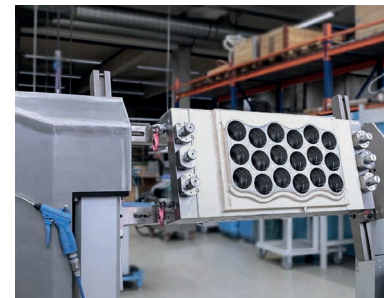

Assembly table Flipper

In conjunction with »Liftmaster«. Our solution for the fast, safe and ergonomic assembly of tools. The assembly table »Flipper« is especially designed for working on tilting tools. The table is limitlessly adjustable. And can be turned to any position. For your comfort. And efficiency.



Flexi-Tab-Box

For spare nick tabs. The Flexi-Tab-Box. If a change of nick tabs is required, all necessary components for a different nick height are readily available. Fast. And simple.



marbanick

Sometimes additional nicks are necessary. In this case, marbanick comes in very handy. It creates flawless and reproducible nicks. Without damaging the line's edge-geometry. Fast. And simple.



mafix|E & mafix|L

When the Flexi-Tab-System is not in use. The mobile nick-grind systems Mafix|E & Mafix|L. You can choose between the electrically or pneumatically powered motor. The minimum nick width is 0.2 mm.



SR|TEC toolbox

It makes steel-rule change child's play. The SR|TEC toolbox. It contains an aluminum hammer. Pliers. Wetstone. Straightening device. Magnifying glass. Magnet holders. And additional safety plates. For a fast change.



SR replacement

We equip existing holders with Marbach-rules. Either of your own production. Or tools from other manufacturers. You can upgrade them by applying Marbach's steel-rule technology. For more performance.



SR test toolkit

You can make samples in your own R&D department. Using the SR test toolkit. We supply you with the matching mount. With a hardened anvil plate. And the fitting steel-rule in changing holders. With spare lines.

ROTARY TOOLS. CUTTING. CREASING. EMBOSSING.

Rotary cutting, creasing and embossing tools. They stand for highest requirements. For precision. For product quality. For high volume. For cigarette boxes. For liquid packaging. For pharmaceutical packaging. For technical applications. And other uses.

We have expanded our work with rotary tools. Created more capacity. More investment. We build cutting, creasing and embossing cylinders in our rotary center. With absolute precision. With a true running accuracy of less than 2 µm. With the latest machines. With extensive experience. And far-reaching competence.

fast

reliable

durable

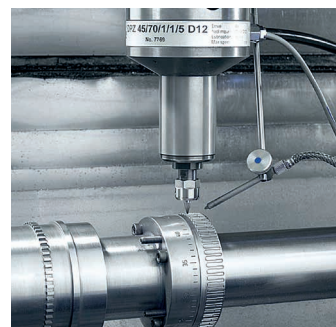
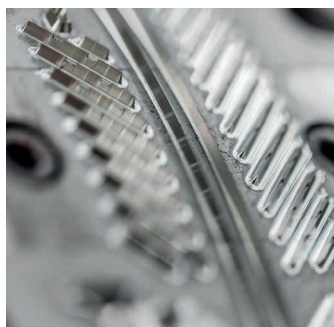
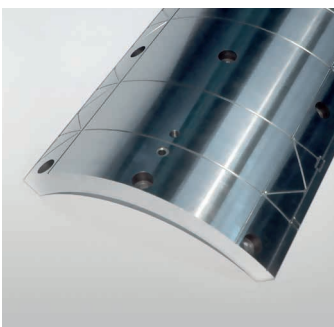

Combined competence.



MR|easy & marbacllick

EFFICIENT AND PRECISE.

You have high demands. Very high. You need a tool that allows top speeds. That is easy to use and produces low vibration. Yet highest precision. That distinguishes itself with optimal temperature distribution. A long tool life span. And a clean cut.

We have the perfect tool for you: the Marbach development MR|easy. With precise cutting parts made of PM steel. This tool corrects its temperature profile automatically. Leads to a constant cutting gap. Over the whole tool. Throughout the entire cycle. And to a short start-up phase. Without pre-heating.

MR|easy is characterized by its excellent product quality. Minimal tolerances. Optimal temperature control. And easy handling. You want even more efficiency? Use MR|easy combined with our marbacllick system.

With MR|easy and marbacllick you save time. Avoid rejects. And count on a tool with a long life span. For highest efficiency.

very high machine speeds

minimal tolerances

reduced setup times

The optimal combination:
MR|easy & marbacllick.

marbaclick.

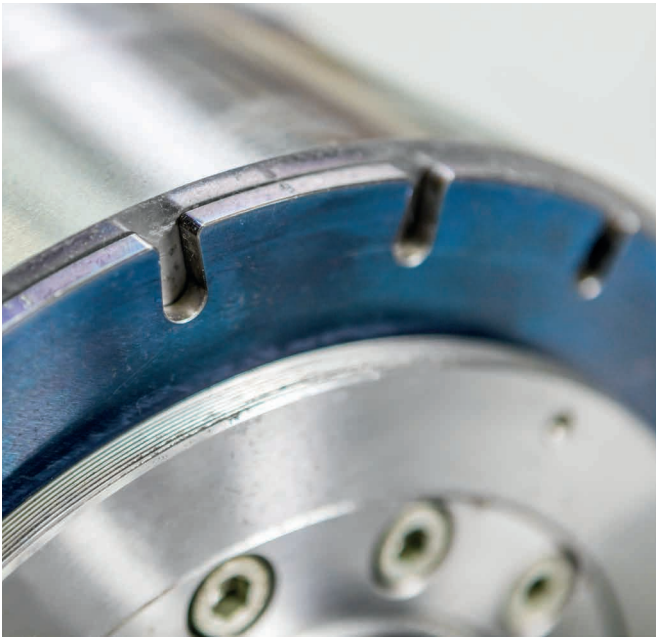

MR|easy with integrated temperature compensation.

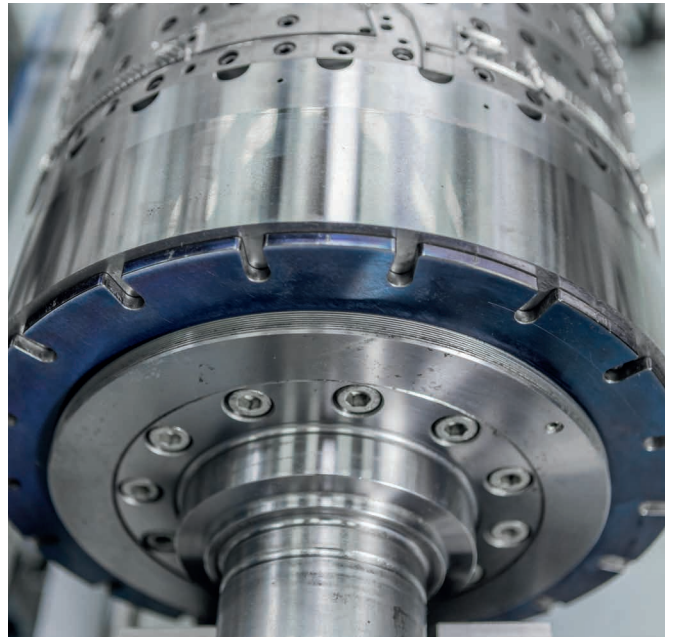

MR|easy (feature 1)

THE TEMPERATURE COMPENSATING ONE.

temperature compensating

wide process window

for long life span

MR|easy



Standard



MR|easy (feature 2)

THE LOW VIBRATING ONE.

low vibrating

protects the knives

reduced tool weight

MR|easy

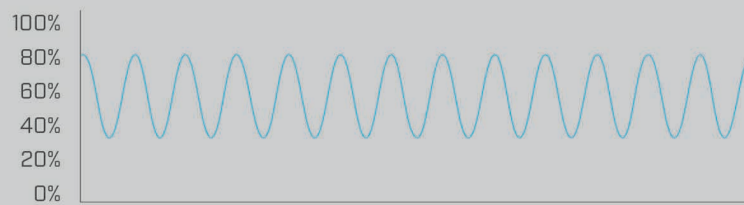

Standard

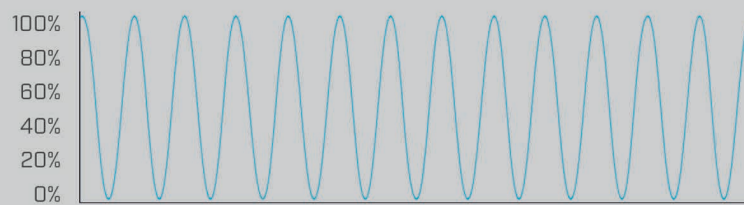

marbaclick (feature 3)

THE SIMPLE ONE.

fast

simple

safe

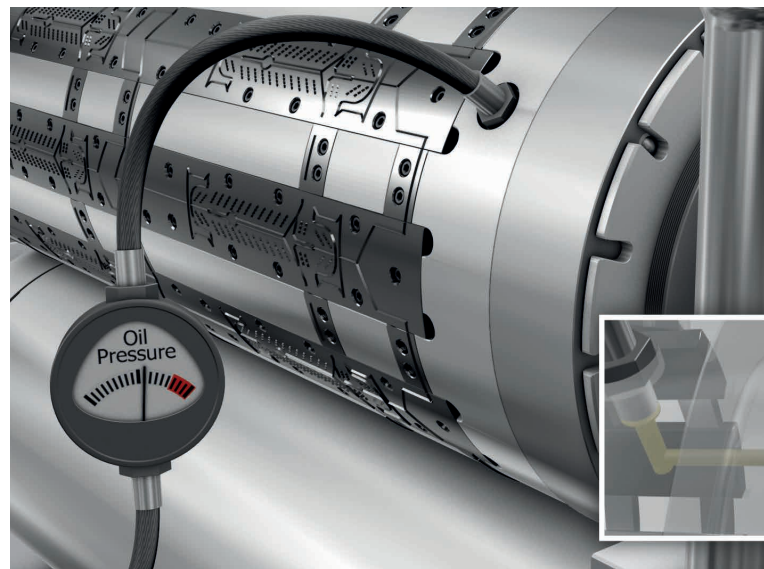

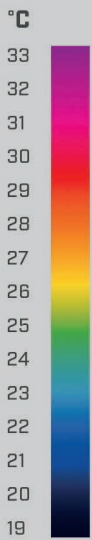

A balanced temperature level is essential for cutting tools. Normally, heat is led away through an external cooling system from the bearings. This involves risks and is expensive. Our MR|easy tool maintains a constant temperature. On its own. With a system for effective temperature compensation in place. Integrated into the tool. This ensures a wide process window. And protects the knives. The system reacts fast. For a simple start-up of your system. Also with cold tools. MR|easy. For tools with maximum tool life span.

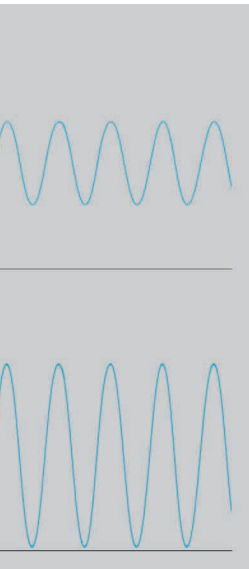

MR|easy can accomplish more than traditionally built rotary tools. Vibration is reduced through its special design and light weight. This extends the tool life span significantly.

MR|easy & marbaclick. Rotary die cutting. The animation. www.marbach.com/easy

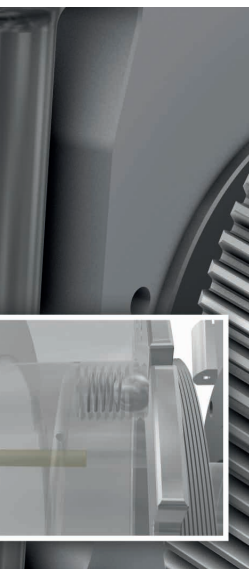

marbaclick allows a fast and save adjustment of the cutting gap. In defined μm -steps. Transparent. And recordable. This simplifies the make-ready process. And protects the knives of your rotary tool.



CUTTING DIES FOR PACKAGING. EXCEPTIONAL PERFORMANCE. CUT PERFECTLY.



Without die cutting there can be no packaging made from carton. Or corrugated board. You need a cutting die that meets all your needs, so your packaging is functional and appealing at the same time.



This depends on many factors. The right die board. The optimal knifing techniques. Choosing the best cutting rule. The correct rubber. And of course the required special applications. Like embossing. Or reverse cutting. Always tailored to the package design.



You are on the safe side with our tools. Technologies for highest performance. And completely convincing results. Turning your packaging into what you desire: an eye-catcher at the point of sale.

Eye-catcher at the point of sale.



CUTTING DIES FOR SPECIAL APPLICATIONS. DETAILED. AND DIVERSE.

Diversity. That is our motto. We do not only manufacture cutting dies for packaging. But also for special applications. We make almost everything possible. With many years of experience. And experts that are specialized in specific areas. In customer service. In CAD. And in production. For your performance needs.

Non-Packaging

Tools with high steel-rule up to 100 mm. With welded rule joints. With minimal bending radii. And custom-made cutting punches. The sky's the limit. Automotive industry. Pharma industry. Plastics industry. Prototyping. Gaming industry. Commercial printing. We supply them all. With different tools. For sensors. For foam. For auto interiors. Surgery accessories. Tablet blisters. For maps. For greeting cards. For credit cards. For deep-drawn parts. For thermoforming tools. For puzzles. For board games. And many more.

Labels

Simple to complex. Cutting dies for labels. In a wide variety. Often a special challenge: die cutting very thin materials. Labels have to be kiss-cut or through-cut. No matter how thin the material is. Our flatbed tools in steel-rule technique are the perfect fit. To fulfil your requirements. With special dieboards. With special cutting rules. For in-mould labels. For PP-labels. And for other plastic labels. For the most diverse application areas. On cars. On beer bottles. On make-up articles. As decal images. Or as plant tags. Highest performance for your labels and stickers.

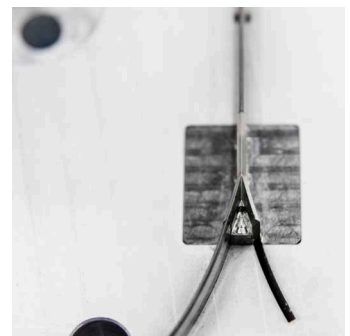
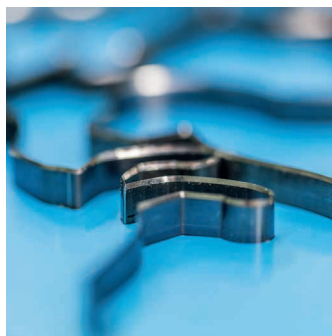
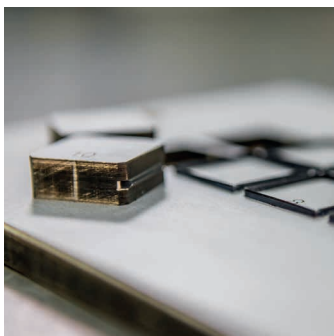



PACKAGING. PERFORMANCE. YOU.

You see: our product portfolio is diverse.
Extensive. And exciting. And offers you many
advantages. Simply perfect performance.
Always a custom fit for you.

Would you like to know more? About Marbach?
About our products?

Please contact us. We look forward to your
inquiries. Your wishes. Your ideas.

Or visit our website.
Find more information. The registration
to our infoletter. And a lot of videos.

www.marbach.com

Marbach Group

Marbach Werkzeugbau GmbH

August-Häußer-Str. 5

74080 Heilbronn

Germany

phone +49 7131 918-0

info@marbach.com

www.marbach.com

**PACKAGING.
PERFORMANCE.
YOU.**